

# USER CARE OF MEDICAL EQUIPMENT

A first line maintenance guide for end users



April 2015

# User Care of Medical Equipment

A first line maintenance guide for end users

**Strengthening Specialised Clinical Services in the Pacific**

*(A DFAT funded initiative)*

**April 2015**



Australian Government

Department of Foreign Affairs and Trade



## Foreword

Pacific Island Countries face many challenges when providing quality health care services. At the 2011 Pacific Ministers of Health and the SSCSiP's Regional meetings the Procurement and Maintenance of Biomedical equipment was identified as one of the most important challenges faced by Pacific Island Countries.

SSCSiP has been working with the Pacific Island Countries to improve the Procurement and Maintenance of Biomedical equipment. This maintenance guide for end users provides guidelines to care and maintain a range of equipment that are commonly used.

The easy-to-follow User Checklists can be easily printed and kept beside respective equipment as a reference and reminder to end-users to conduct maintenance on equipment at regular intervals.

We are certain that the manual would empower end-users with basic troubleshooting and maintenance of equipment they use, contributing towards improved clinical and biomedical services.



Prof Ian Rouse  
Dean  
College of Medicine Nursing & Health Sciences  
Fiji National University

September 2014

The User Care of Medical Equipment Manual has been compiled by Mr Andrew Gammie of Fishtail Consulting Ltd (UK).

## Contents

Foreword .....	2
Contents .....	3
Chapter 1. Introduction .....	4
Chapter 2. How to use this manual .....	5
Chapter 3. Provision for Maintenance .....	7
Chapter 4.1 Anaesthetic Machines and Ventilators.....	9
Chapter 4.2 Autoclaves and Sterilizers .....	12
Chapter 4.3 Dental Unit .....	15
Chapter 4.4 ECG (Electrocardiograph) Machines .....	18
Chapter 4.5 Electronic Diagnostic/Monitoring Equipment .....	21
Chapter 4.6 Electrosurgical Units (ESU) and Cautery Machines.....	24
Chapter 4.7 Endoscopes .....	27
Chapter 4.8 Incubators (Infant).....	30
Chapter 4.9 Laboratory Equipment.....	33
Chapter 4.10 Lamps .....	36
Chapter 4.11 Nebulizers.....	39
Chapter 4.12 Oxygen Concentrators.....	42
Chapter 4.13 Oxygen Cylinders and Flowmeters .....	45
Chapter 4.14 Pulse Oximeters.....	48
Chapter 4.15 Refrigerators and Freezers .....	51
Chapter 4.16 Scales.....	54
Chapter 4.17 Sphygmomanometers (B.P. sets) .....	57
Chapter 4.18 Stethoscopes .....	60
Chapter 4.19 Suction Machines (Aspirators).....	63
Chapter 4.20 Tables – (Operating Theatre and Delivery) .....	66
Chapter 4.21 Ultrasound Machines.....	69
Chapter 4.22 X-Ray Machines.....	72
Chapter 5. Handling Waste .....	75
Chapter 6. Installation of equipment.....	78
Chapter 7. Disposal of equipment.....	80
Chapter 8. Basics of electrical safety .....	81
Chapter 9. References .....	85

## Chapter 1. Introduction

### 1. *The purpose of this manual*

This manual is intended to be a guide for the medical equipment user to carry out basic equipment care tasks. As the majority of equipment problems are either simple or user-related it is the aim that the better care and regular maintenance enabled by this manual will have a significant positive effect on the delivery of healthcare. The tasks are limited to simple ‘first-line’ maintenance, that is:

- tasks that can be done by the user of the equipment
- tasks that take place at the point of equipment use
- tasks that do not require the opening of the main body of the equipment

This manual is not intended as a complete maintenance guide – that is the role of a biomedical technician. Neither is it intended to be a guide to the actual use of equipment – it is assumed that the user is trained in the correct operation of the equipment. Users are asked to note that while every care has been taken to make the contents as clear and accurate as possible, neither the authors nor SCSiP can take responsibility for the results of actions taken as a consequence of using this manual.

### 2. *The format of this manual*

The text of the manual is in English and is designed for on-line access as well as hardcopy prints. General topics on maintenance and disposal are covered by individual chapters. Chapter 4 covers the most commonly found equipment in detail. Each equipment section comprises:

- a brief description of the function and working of the equipment
- a line drawing of the equipment and its parts
- a troubleshooting checklist for common problems and their solution
- a user care checklist for daily and weekly tasks

The checklists are on separate pages so they can be copied and laminated for display near the equipment.

The choice of which equipment to include was guided initially by the 2010 revision of the Indian Public Health Standards. Equipment specified for health institutions up to the size of a 50 bed hospital was included, on the basis that this will cover the vast majority of simple equipment also found elsewhere. Other equipment was added after consultation with attendees of the WHO Global Forum on Medical Devices 2013 and the team of SCSiP Project in Fiji.

### 3. *Acknowledgements*

This manual draws on work done by many in this field. In particular, the authors acknowledge:

The UK Department for International Development for initial project funding  
The World Health Organization for permission to use material  
Voluntary Service Overseas, UK for permission to use material  
The Nick Simons Institute, Nepal for permission to use material  
Crown Agents, UK for initial project support and management  
The Ministry of Health and Family Welfare, India.  
Engineers S B Sinha and S Bindal, India, for the first version of the manual.  
SSCSiP for supporting this revision of the manual in 2014

A R Gammie, N Kapadia April 2015.

## Chapter 2. How to use this manual

The tasks outlined in this manual are only part of the picture. Healthcare technology management needs to involve all staff in the hospital. It is thus essential that some discussion on using this manual takes place with managers as well as technical and clinical personnel. Maintenance checklists are no good unless someone actually does the job!

### 1. Management

#### 1.1. Involve Managers

Chapter 3 describes maintenance within the context of the whole process of healthcare technology management. It will be helpful to discuss these with the people in charge of purchasing and storing equipment and also with those in overall charge of the institution. It is important to explain that day to day maintenance tasks cannot solve all of the problems. If poor equipment is supplied or rats have eaten the wires, there is little point cleaning it! If a major problem occurs, trained technical help will be needed. Encourage your workplace to plan for the whole life cycle of equipment – see chapter 3 - or use the material referred to in chapter 9.

#### 1.2. Involve Users

The key to effective care is keeping it regular. This means that people need to know WHAT to do, WHEN to do it and WHO is going to do it. Users must be allowed time in their regular schedule to carry out these tasks – they will not take long, but the benefits will be enormous. In each department, it will be helpful to assign responsibility for each item of equipment, and if possible insert the phrase ‘care of equipment’ into their job description. Each person can then ensure that the tasks are actually carried out. It will help to have a nominated person in overall charge of equipment for each section of the site, so that cover can be arranged when people transfer or are absent.

### 2. Maintenance

#### 2.1. Plan the tasks

The user care tasks are placed in daily and weekly checklists. This will help in planning time for them to be carried out. In most cases for daily tasks, the beginning of the working day will be best, but any time will suit as long as the job is done. For weekly tasks, it may be easier to allocate a different day for each type of equipment, in order to spread the load through the week. A simple timetable with the person responsible can be used as a reminder.

#### 2.2. Display the lists

The user care checklists are designed to fit on a single page per section. This makes it easy to print or copy them and display them near the equipment. The lists will only be useful if they are easy to see, so placing them on the equipment or on a wall nearby will be best. Each page could be covered with plastic laminate or taped inside a plastic wallet. The same could be done with the troubleshooting checklists, or these could be stored nearby for when needed.

#### 2.3. Record the work

It is normally helpful to have some way of recording when user care has been done. This will tell colleagues or the next shift that the daily check has been carried out, or remind the user themselves that the weekly job has been done. It can also be helpful to show supervisors and patients that care is being taken of equipment. An example record sheet is shown on the next page, which can be copied for use with each piece of equipment.

User care task record sheet – sign and date when user care done

Equipment:..... Location:.....

Daily Tasks

Date	Signed	Date	Signed	Date	Signed	Date	Signed	Date	Signed

Weekly tasks

Date									
Signed									

## Chapter 3. Provision for Maintenance

### 1. The equipment management cycle

Maintenance of healthcare equipment is not just a question of repairing broken things. It can be Corrective Maintenance (repair) but also Preventive (or Planned) Maintenance, which makes sure problems either do not occur or are picked up when they are small. Both are an integral part of managing the whole lifecycle of equipment. The following diagram illustrates this cycle:

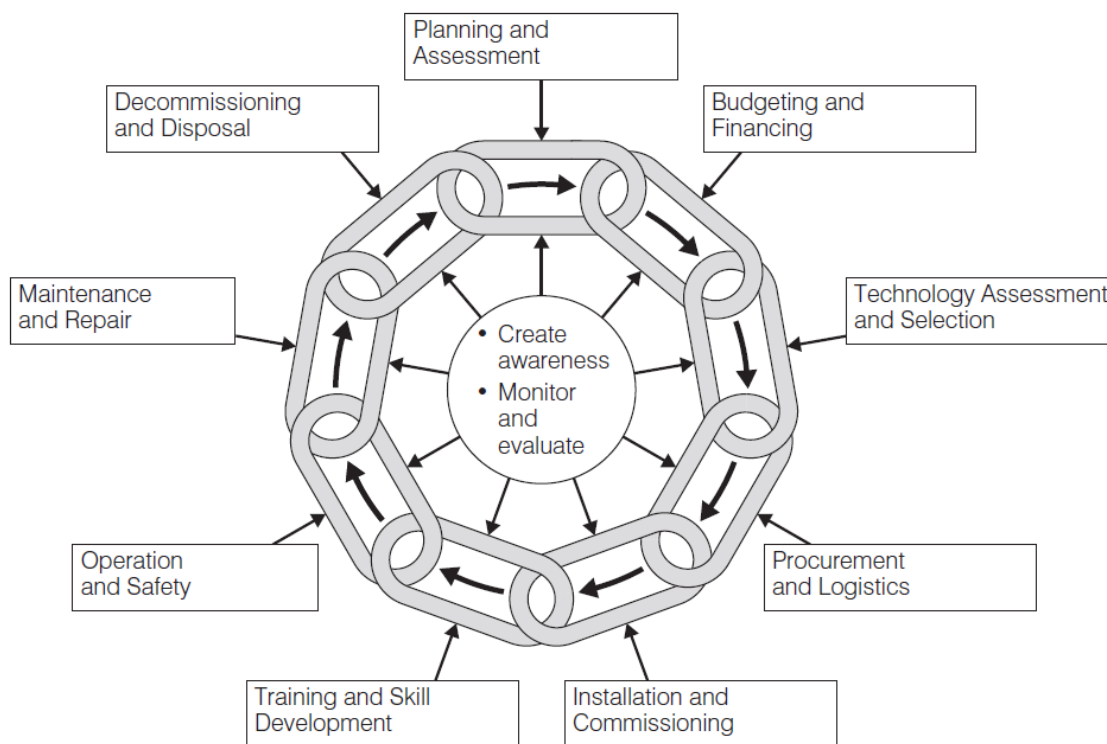

It can be seen that maintenance and repair is just one element. To make the whole cycle work properly, a number of different inputs are required. A full description of such a system, and the steps needed to begin one, will be found in the “How to Manage Series for Healthcare Technology” listed in chapter 9.

### 2. Recommended resources

The user should not be left on their own. Once a piece of equipment is installed, commissioned and accepted and once the user has been fully trained in operation, they will need these resources to carry out the use and maintenance of the equipment well:

- Manuals in a fluent language
- Scheduled Maintenance
- Repair Services
- Maintenance Contract Management
- Consumables supply
- Spares Supply



### **3. Levels of Maintenance**

There are three levels of maintenance commonly identified:

- Level 1, User (or ‘first-line’)
  - The user or technician will clean the filters, check fuses, check power supplies etc. without opening the unit and without moving it away from the point of use. Note that even this level of maintenance will require infection prevention measures for many types of equipment.
- Level 2, Technician
  - It is recommended to call the local technician when first-line maintenance cannot rectify a fault or when a six monthly check is due.
- Level 3, Specialized
  - Equipment such as CT Scanners, MRIs etc. will need specialized engineers and technicians trained in this specific equipment. They are normally employed by third party or vendor companies.

As stated in the introduction, this manual is focussed on the User or First-Line Maintenance level. The reference section can be used to discover material for the other maintenance levels. Rather than ‘maintenance’, which implies specialist training, in this manual we will refer to level 1 as ‘User Care’.

## Chapter 4.1 Anaesthetic Machines and Ventilators

### **Function**

The anaesthetic machine (or anaesthesia machine in America) is used by anaesthesiologists and nurse anaesthetists to support the administration of anaesthesia. The most common type of anaesthetic machine is the continuous-flow anaesthetic machine, which is designed to provide an accurate and continuous supply of medical gases (such as oxygen and nitrous oxide), mixed with an accurate concentration of anaesthetic vapour (such as halothane or isoflurane), and deliver this to the patient at a safe pressure and flow. Modern machines incorporate a ventilator, suction unit, and patient monitoring devices. Ventilators are designed to maintain patient breathing when they are incapable of doing so themselves effectively. They carefully maintain pressure, flow and breathing rate to the levels set by clinical staff, and set off an alarm when these levels are not maintained.

### **How it works**

Oxygen ( $O_2$ ), nitrous oxide ( $N_2O$ ) and sometimes air sources are connected to the machine. Through gas flowmeters (or rotameters), a controlled mixture of these gases along with anaesthetic vapour passes through a vaporizer and is delivered to the patient. With ventilators or a re-breathing patient circuit, soda lime canisters are used to absorb the exhaled carbon dioxide and fresh gases are added to the circuit for reuse. Pressure gauges are installed on the anaesthesia machine to monitor gas pressure. Generally, 25% (or 21%) oxygen is always kept in the circuit (delivered to patient) as a safety feature. The device which ensures this minimum oxygen in the circuit is called a hypoxic guard. Some basic machines do not have this feature, but have a nitrous lock which stops the delivery of  $N_2O$  in absence of  $O_2$  pressure. Machines give various alarms to alert operators.

Ventilators are powered by electricity with battery backup, though some models use compressed gas, and have several modes of operation which assist or control patient breathing, or regulate by controlling volume or pressure. Combination modes are also available. The unit may include a heater and/or humidifier to decrease respiratory stress.

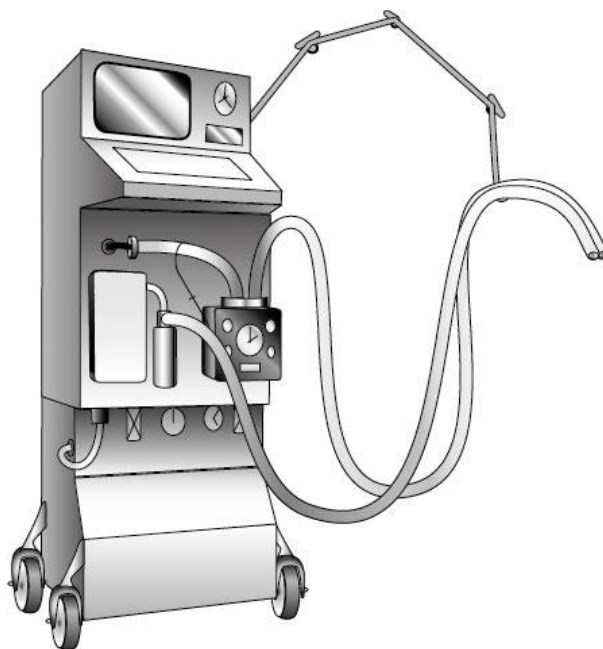
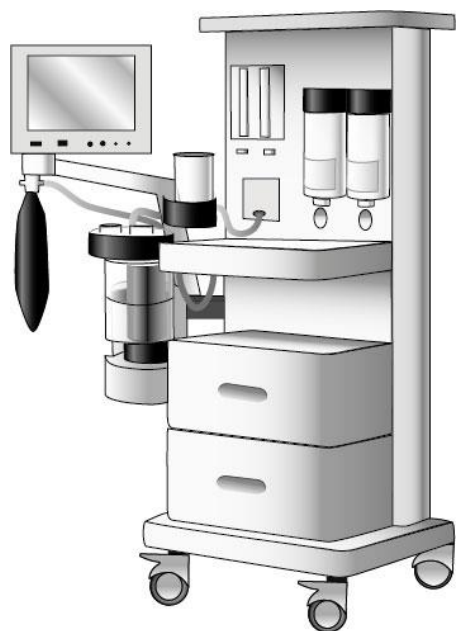

## Troubleshooting – Anaesthesia Machines and Ventilators

Fault	Possible Cause	Solution
1. Equipment is not running	No power at mains socket	Check power switch is on. Replace fuse with correct voltage and current rating if blown. Check mains power is present at socket using equipment known to be working. Contact electrician for rewiring if power not present.
	Electrical cable fault	Refer to electrician for repair
2. No gas output	No O <sub>2</sub> pressure in cylinder / gas supply.	Restore gas supply or replace gas cylinders.
	Check pressure gauges for gas pressure (about 4 bar or 4 kg/cm <sup>2</sup> )	Replace O <sub>2</sub> cylinder and/or N <sub>2</sub> O cylinder in case of low pressure.
3. O <sub>2</sub> failure, power failure or breathing alarm not working	Alarm battery is low.	Call biomedical technician to fix the problem.
	Alarm device is not working	
4. Machine has leaks	Poor seal (commonly occurring around tubing connections, flow valves and O <sub>2</sub> / N <sub>2</sub> O yokes)	Clean leaking seal or gasket, replace if broken. If leaks remain, call technician for repair.
	Cylinders not seated in yokes properly	Refit cylinders in yokes and retest. If leaks remain, call technician for repair.
5. Flowmeter fault	Over tightening of the needle valve or sticking of the float / ball	Refer to biomedical technician
6. Electrical shocks	Wiring fault	Refer to electrician immediately

User Care Checklist – Anaesthesia Machines and Ventilators

<b>Daily</b>	
Cleaning	<ul style="list-style-type: none"> <li>✓ Remove any dust, dirt, water, waste matter, tape and paper</li> </ul>
Audio-Visual checks	<ul style="list-style-type: none"> <li>✓ If any leak is audible, check with soapy solution</li> <li>✓ Check all seals, connectors, adapters and parts are tight</li> <li>✓ Check all moving parts move freely, all holes are unblocked</li> </ul>
Function checks	<ul style="list-style-type: none"> <li>✓ Report any faults to technician immediately</li> <li>✓ After checks, depressurize system and replace all caps / covers</li> </ul>

<b>Weekly</b>	
Cleaning	<ul style="list-style-type: none"> <li>✓ Clean inside and outside with damp cloth and dry off</li> <li>✓ Remove dirt from wheels/any moving parts</li> </ul>
Audio-Visual checks	<ul style="list-style-type: none"> <li>✓ Check connections for leakage with soap solution and dry off</li> <li>✓ Check all fittings and valves for proper assembly</li> <li>✓ Replace soda lime if it has changed colour</li> <li>✓ Replace any deteriorated hoses and tubing</li> <li>✓ If seal, plug, cable or socket are damaged, replace</li> </ul>
Function checks	<ul style="list-style-type: none"> <li>✓ When next used, check pressure gauges rise</li> <li>✓ When next used, check there are no leaks</li> </ul>

<b>Every six months</b>	
Biomedical Technician check required	

## Chapter 4.2 Autoclaves and Sterilizers

### ***Function***

Sterilization is the killing of microorganisms that could harm patients. It can be done by heat (steam, air, flame or boiling) or by chemical means. Autoclaves use high pressure steam and sterilizers use boiling water mixed with chemicals to achieve this. Materials are placed inside the unit for a carefully specified length of time. Autoclaves achieve better sterilization than boiling water sterilizers. Autoclaves can be small table top designs (e.g. dental departments), portable upright units (e.g. small clinics) or large fixed systems.

### ***How it works***

Heat is delivered to water either by electricity or flame. This generates high temperature within the chamber. The autoclave also contains high pressure when in use, hence the need for pressure control valves and safety valves. Users must be careful to check how long items need to be kept at the temperature reached.



## Troubleshooting – Autoclaves and Sterilizers

Fault	Possible Cause	Solution
1. Equipment is not heating	<p>No power at mains socket</p> <p>Electrical cable fault</p> <p>Damaged heating element</p>	<p>Check power switch is on. Replace fuse with correct voltage and current rating if blown. Check mains power is present at socket using equipment known to be working. Contact electrician for rewiring if power not present.</p> <p>Try cable on another piece of equipment. Contact electrician for repair if required.</p> <p>Send to electrician if broken or covered in limescale (see picture below). Remove small amounts of limescale by light scraping and long soaking in distilled water.</p>
2. Pressure rises above the marked level	Blocked valve	<p>Clean the pressure regulating valve, safety valve.</p> <p>Pressure vessel may be over filled.</p> <p>Retest autoclave under pressure with water only.</p>
3. Steam is constantly escaping	Poor seal	<p>Clean leaky valve and hole, replace if defective.</p> <p>Clean leaking seal or gasket, replace if broken.</p>
4. Electrical shocks	Wiring fault	Refer to electrician

Limescale on heating element



User Care Checklist – Autoclaves / Sterilizers

<b>Daily</b>	
Cleaning	<ul style="list-style-type: none"><li>✓ Remove any dust / dirt with damp cloth and dry off</li><li>✓ Remove water and waste matter from inside</li></ul>
Visual checks	<ul style="list-style-type: none"><li>✓ Check all screws, connectors and parts are tightly fitted</li><li>✓ Check all moving parts move freely, all holes are unblocked</li></ul>
Function checks	<ul style="list-style-type: none"><li>✓ Use troubleshooting guide if problems occur</li></ul>

<b>Weekly</b>	
Cleaning	<ul style="list-style-type: none"><li>✓ Unplug, clean inside and outside with damp cloth and dry off</li><li>✓ Remove gasket, clean with a damp cloth and replace</li></ul>
Visual checks	<ul style="list-style-type: none"><li>✓ Scrape off any small deposits of limescale</li><li>✓ Send for repair if heating element covered with limescale</li><li>✓ If plug, cable or socket are damaged, replace</li></ul>
Function checks	<ul style="list-style-type: none"><li>✓ When next used, check pressure / temperature gauges rise</li><li>✓ When next used, check there are no leaks</li></ul>

<b>Every six months</b>	
Biomedical Technician check required	

## Chapter 4.3 Dental Unit

### **Function**

A dental unit comprises a patient chair (often motorised), inspection light, sink and drain for swilling and multiple connectors for handpieces. Handpieces can be for drills, oral suction, ultrasonic scalars and polishers. The whole unit is normally a single installation and is the main feature in a dental department offering cleaning, fillings, dental repairs, extractions and checkups.

The unit must be used under the direction of a trained operator. This is particularly important for infection prevention. These notes do not contain full guidance for safe use of dental units, they merely focus on equipment care.

### **How it works**

Within the base unit, a compressor generates air at pressure, a vacuum pump provides suction, and a water pump provides cooling and mouthwash water. Control is effected by fingertip controls on the handpiece, foot switch control of air, water and motors, and control panel operation of lights and chair movement.

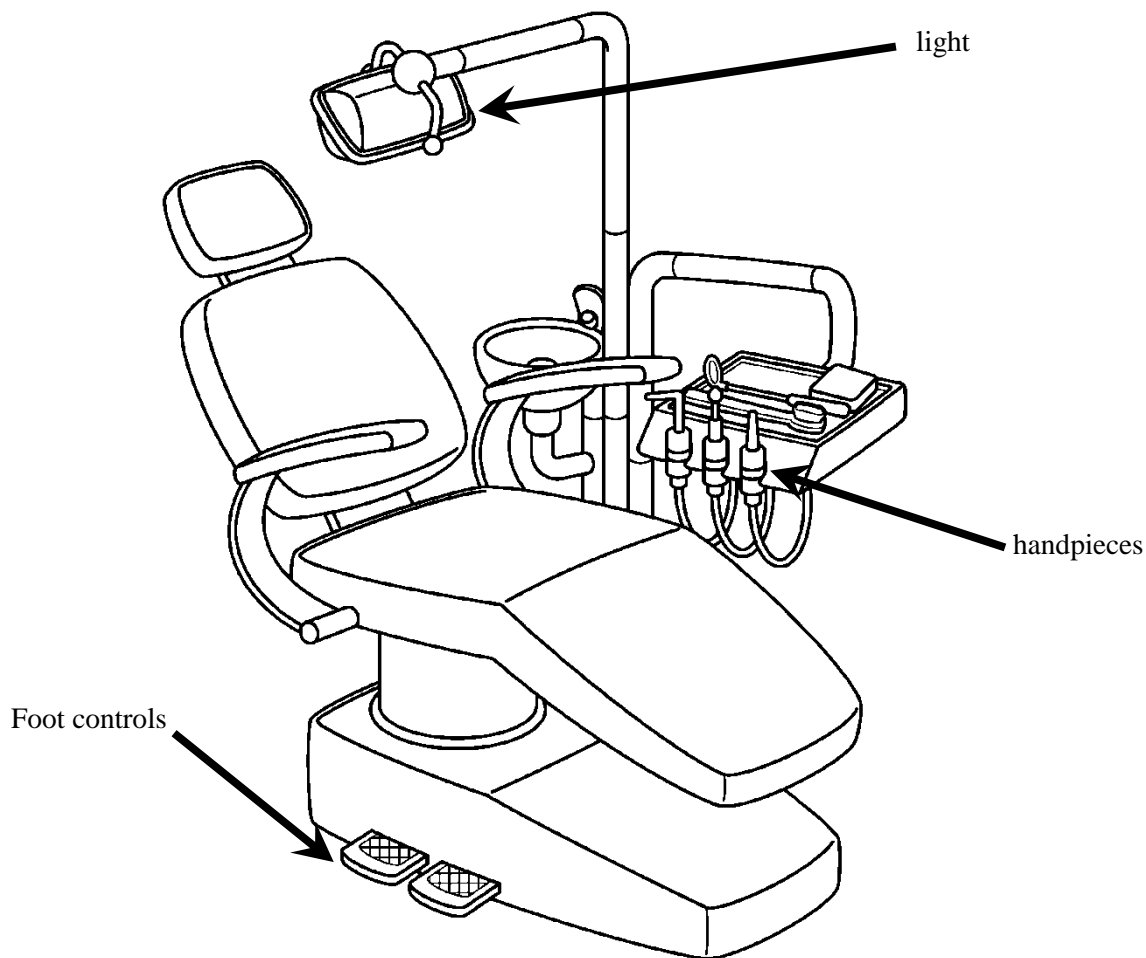



### Troubleshooting – Dental Unit

Fault	Possible Cause	Solution
1. Unit not operating, power failure.	No power from mains socket	Check mains switch is on and plug inserted. Replace fuse with correct voltage/current if blown. Check mains power is present at socket using equipment known to be working. Contact electrician for repair if required.
	The unit's circuit breaker has been set off.	Press reset button if present. Note there may be separate fuses / breakers for the different parts of the dental unit (compressor, pump, chair etc.).
	Electrical cable fault	Check power cable is not damaged. Contact electrician for repair if required.
2. Light not functioning	System electrical fault	Check as above
	Controls not correctly used	Check operator manual for control panel configuration
	Light bulb broken	Replace bulb according to manual with correct type
3. Chair not moving	Electrical fault (electrical systems)	Check electrical problems as above in section 1.
	Hydraulic fault (hydraulic systems)	Check level of hydraulic fluid in system, refill if required. Check pedals operate smoothly, lubricate and clean if required.
4. Handpiece jammed or noisy	Mechanical fault	Refer to specialist technician.
5. Water or air leakage	O-ring sealing worn	Replace O-ring according to manufacturer's instructions.
6. No water or air	Valves are closed or not connected	Check inlets are connected. Check filters are clean. Check valves are all open.
7. Electrical shocks	Wiring fault	Refer to electrician

## User Care Checklist – Dental Unit

### Daily

Cleaning	<ul style="list-style-type: none"><li>✓ Remove any dust / dirt with damp cloth and dry off</li><li>✓ Clean all surfaces near patient with disinfectant</li></ul>
Visual checks	<ul style="list-style-type: none"><li>✓ Check for water, oil or air leakage, cleaning and repairing if required</li></ul>
Function checks	<ul style="list-style-type: none"><li>✓ Lubricate and sterilise handpieces according to manufacturer's instructions</li></ul>

### Weekly

Cleaning	<ul style="list-style-type: none"><li>✓ Remove dirt and dust from compressor with soft, dry brush or cloth</li><li>✓ Check all filters and clean if necessary</li></ul>
Visual checks	<ul style="list-style-type: none"><li>✓ Check all screws, tubes and parts are tightly fitted</li><li>✓ If mains plug, cable or socket are damaged, replace</li></ul>
Function checks	<ul style="list-style-type: none"><li>✓ Check light, footswitch and control panel operation</li><li>✓ Check full movement of chair</li></ul>

### Every six months

Biomedical Technician check required

## Chapter 4.4 ECG (Electrocardiograph) Machines

### **Function**

ECG machines are used to monitor the electrical activity of the heart and display it on a small screen or record it on a piece of paper. The recordings are used to diagnose the condition of the heart muscle and its nerve system.

### **How it works**

The electrical activity is picked up by means of electrodes placed on the skin. The signal is amplified, processed if necessary and then ECG tracings displayed and printed. Some ECG machines also provide preliminary interpretation of ECG recordings. There are 12 different types of recording displayed depending upon the points from where the recordings are taken. Care must be taken to make the electrode sites clean of dirt before applying electrode jelly. Most problems occur with the patient cables or electrodes.

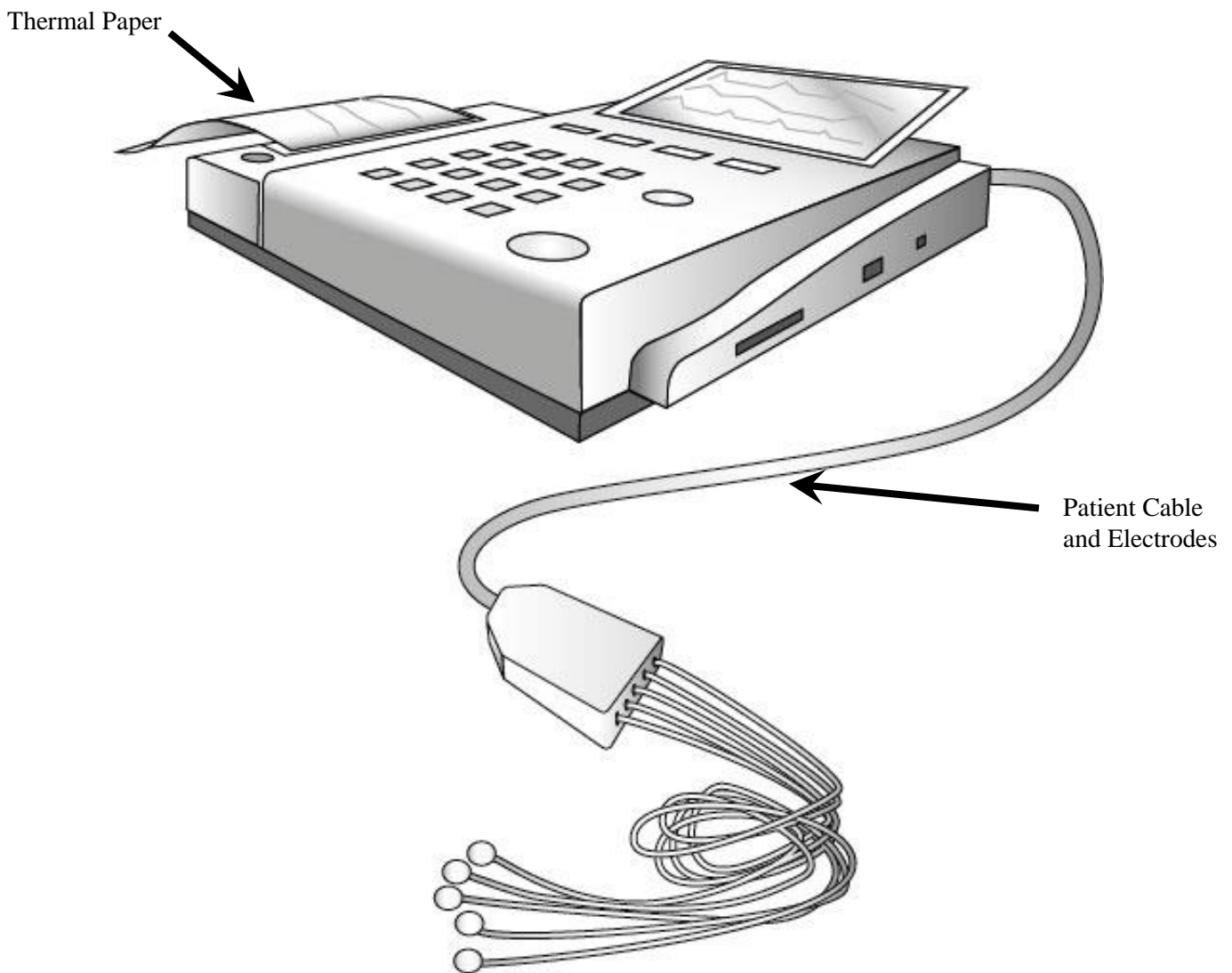

## Troubleshooting – ECG Machines

Fault	Possible Cause	Solution
1. ECG traces have artefacts or base line drift	Improper earthing	<p>Check for good connection of reference electrode</p> <p>Try with battery power only. If the recording improves then problem is with earthing. Check the earthing</p> <p>Power the machine from another outlet with proper electrical earth</p>
2. ECG traces have artefacts in one or more traces, but not in all traces	Improper electrode connection with patient or problem with the ECG cable	<p>Check the patient cable continuity with continuity tester. Replace cable if found faulty</p> <p>Check the electrodes expiration date</p> <p>Check patient skin preparation</p> <p>Reposition electrodes</p> <p>Check limb electrodes and chest electrodes for damage, replace if necessary</p>
3. Paper feed not advancing	Incorrect paper loading	Use instructions to reload paper
4. Printing not clear or not uniform	Printing head problem	<p>Adjust the printing head temperature or position</p> <p>Clean the printing head with head cleaner. If no improvement, replace the printing head.</p> <p>Check the paper roller and replace if not smooth</p>
5. The machine shuts down after a few minutes while on battery power.	Problem with battery or charging circuit	<p>Recharge the unit overnight</p> <p>If there is no improvement then replace the battery (if accessible)</p> <p>If still no improvement, refer to technician</p>

### User Care Checklist – ECG Machines

<b>Daily</b>	
Cleaning	<ul style="list-style-type: none"><li>✓ Clean off dust with dry cloth</li><li>✓ Wipe gel off reusable electrodes after every use</li></ul>
Visual checks	<ul style="list-style-type: none"><li>✓ Check that battery charge indicator, power indicator and patient cable connector indicators are working</li></ul>
Function checks	<ul style="list-style-type: none"><li>✓ Check operation of machine before use using 1mV pulse</li><li>✓ Check the baseline of the ECG recording is steady</li><li>✓ Check the printing is clear and replace dust cover</li></ul>

<b>Weekly</b>	
Cleaning	<ul style="list-style-type: none"><li>✓ Clean the printing head, electrodes and connectors</li></ul>
Visual checks	<ul style="list-style-type: none"><li>✓ Check all cables are not bent, knotted or damaged</li><li>✓ Replace any damaged electrical plugs, sockets or cables</li><li>✓ Check all knobs, switches and indicators are tightly fitted</li></ul>
Function checks	<ul style="list-style-type: none"><li>✓ Check the operation of recordings with 1mV pulse button</li><li>✓ Check battery power can operate the equipment</li></ul>

<b>Every six months</b>
Biomedical Technician check required

## Chapter 4.5 Electronic Diagnostic/Monitoring Equipment

### Function

There are many items of equipment in a hospital that use electronics for operation. The maintenance of such equipment is a task for specialised and trained staff. However, regular inspection and cleaning will help such equipment last for a long time and deliver safe function. These are tasks that the equipment user can carry out and should be done regularly, as laid out on the checklists on the next pages.

The types of equipment that might be included in this category are for instance audiometers, blood gas analyzers, cardiac monitors, cardiocyclographs (CTGs), cryoprobes, defibrillators, infusion pumps and stimulators. .

### How it works

The electrical section of the machine that is most important for safety, and also is the most likely to give problems, is the power supply. See chapter 8 on electrical safety for the background to this. The power supply converts the voltage to a lower, stable value to make the equipment work and also protects the patient from the mains voltage. Any damage to the power supply, or any liquid spilled near it, is very serious indeed. The user care checklist therefore majors on checking the cables, fuses and power connectors. If a device uses low voltage batteries, it is safer to use. In this case, the user should take care that the batteries are removed if the equipment will not be used for longer than one month, as chemical spillage can occur. Rechargeable batteries must be kept topped up with charge.

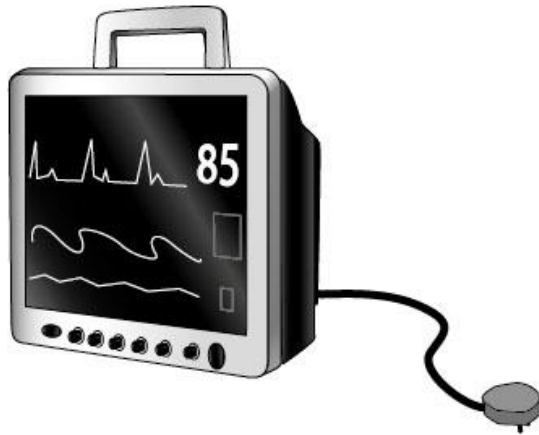

Items of electromedical equipment, with internal power supplies.



External power supply mounted in cable



## Troubleshooting – Electronic Diagnostic/Monitoring Equipment

Fault	Possible Cause	Solution
1. Equipment is not running	No power from mains socket  Electrical cable fault	Check power switch is on. Replace fuse with correct voltage and current rating if blown. Check mains power is present at socket using equipment known to be working. Contact electrician for rewiring if power not present.  Try cable on another piece of equipment. Contact electrician for repair if required.
2. Fuse keeps blowing	Power supply or cable fault	Refer to electrician
3. Equipment not fully operational	Part malfunction	Check controls for correct positioning and operation (refer to user manual)  Check all bulbs, heaters and connectors for function. Repair or replace if necessary.  Check patient connection, using gel, pads or straps as directed in user manual.
4. Signals erratic or large	Reference connection loose  Wire broken inside cable (due to bending or crushing)  Dirt build up on electrodes or contacts	Check reference connection for good contact  Replace with spare cable  Clean as instructed in the user manual
5. Electrical shocks	Wiring fault	Refer to electrician

User Care Checklist – Electronic Diagnostic/Monitoring Equipment

<b>Daily</b>	
Cleaning	<ul style="list-style-type: none"> <li>✓ Wipe dust off exterior</li> <li>✓ Remove any tape, gel, paper or foreign body from equipment</li> </ul>
Visual checks	<ul style="list-style-type: none"> <li>✓ Check all fittings and accessories are mounted correctly</li> <li>✓ Check there are no cracks in covers or liquid spillages</li> </ul>
Function checks	<ul style="list-style-type: none"> <li>✓ If in use that day, run a brief function check before clinic</li> <li>✓ Cover equipment after checks</li> </ul>

<b>Weekly</b>	
Cleaning	<ul style="list-style-type: none"> <li>✓ Unplug, clean outside with damp cloth and dry off</li> <li>✓ Clean any filters or covers as directed by user manual</li> </ul>
Visual checks	<ul style="list-style-type: none"> <li>✓ Check all screws and parts are fitted tightly</li> <li>✓ Check mains plug screws are tight</li> <li>✓ Check mains cable has no bare wire and is not damaged</li> </ul>
Function checks	<ul style="list-style-type: none"> <li>✓ Check any paper, oil, batteries etc. required are sufficient</li> <li>✓ Check all switches operate correctly</li> </ul>

<b>Every six months</b>	
Biomedical Technician check required	



## Chapter 4.6 Electrosurgical Units (ESU) and Cautery Machines

### Function

Electrosurgery is the application of a high-frequency electric current to biological tissue as a means to cut, coagulate, desiccate, or fulgurate tissue. Its benefits include the ability to make precise cuts with limited blood loss in hospital operating rooms or in outpatient procedures. Cautery, or electrocautery, is the application of heat to tissue to achieve coagulation. Although both methods are sometimes referred to as 'surgical diathermy', this chapter avoids the term as it may be confused with therapeutic diathermy, which generates lower levels of heat within the body.

### How it works

In electrosurgical procedures, the tissue is heated by an alternating electric current being passed through it from a probe. Electrocautery uses heat conduction from an electrically heated probe, much like a soldering iron. Electrosurgery is performed using an electrosurgical generator (also referred to as power supply or waveform generator) and a hand piece including one or several electrodes, sometimes referred to as an 'RF Knife', or informally by surgeons as a "Bovie knife" after the inventor. Bipolar electrosurgery has the outward and return current passing through the handpiece, whereas monopolar electrosurgery returns the current through a plate normally under the patient. Electrosurgery is commonly used in dermatological, gynecological, cardiac, plastic, ocular, spine, ENT, orthopedic, urological, neuro- and general surgical procedures as well as certain dental procedures.

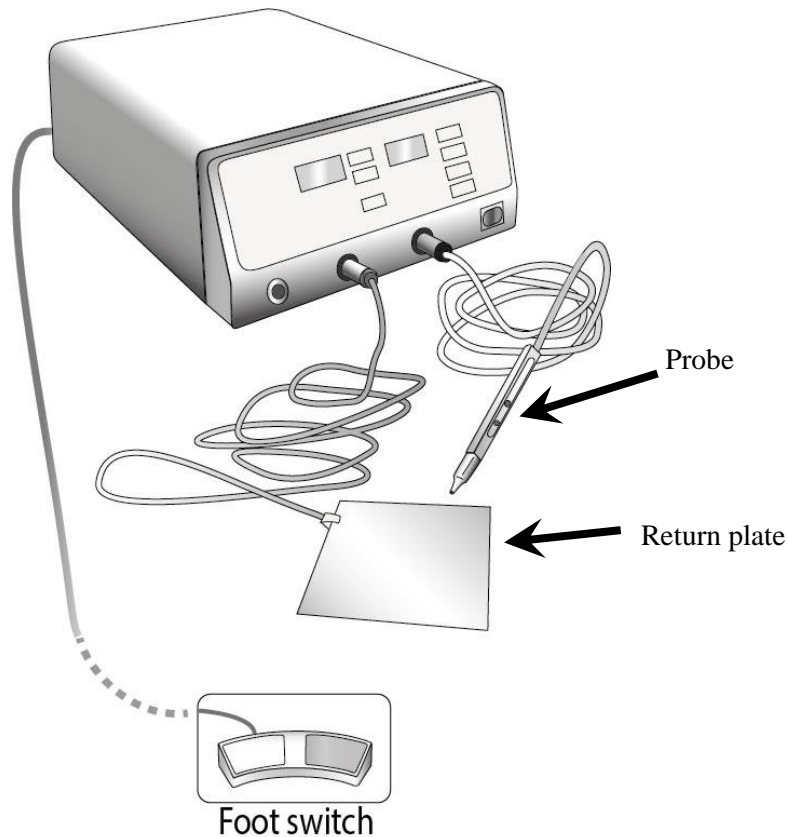

## Troubleshooting – Electrosurgery Units / Cautery Machines

Fault	Possible Cause	Solution
1. Equipment is not turning on	No power from mains socket	Check power switch is on. Replace fuse with correct voltage and current if blown. Check mains power is present at socket using equipment known to be working. Contact electrician for rewiring if power not present.
	Electrical cable fault	Try cable on another piece of equipment. Contact electrician for repair if required.
2. Equipment is on but shows error signal	Footswitch pedal may have been depressed as unit is turned on or front panel buttons may be stuck.	Note error code and turn unit off. Check footswitch and front panel buttons. Disconnect all foot pedals. Turn on unit again.
	Probe, patient cable or plate malfunction	Check connections and plugs on all cables are tight
	Possible internal malfunction	Call biomed technicians.
3. Equipment is on but output is absent, weak or intermittent	Power setting is too low	Adjust power, check manual
	Malfunctioning accessory	Check connection or replace item
	Incomplete or incorrect connection	Check correct probe / footswitch cord are well connected
	Possible internal malfunction	Call biomedical technician
4. Continuous interference with monitors	Faulty earth connection	Check all monitors and power connections. Use separate outlets for each medical device.
	Poor filtering systems in monitoring equipment	Replace monitoring device
5. Monitor interference occurs only when electrosurgery is activated	Metal-to-metal sparking	Check all connections are tight
	Cords and cables are bundled, touching or damaged	Remove cable cluttering, replace damaged cords
	High power setting	Reduce power setting, use blend mode
	Continued interference	Contact biomedical technician
7. Pacemaker or internal cardiac defibrillator interference	Equipment activation is causing battery or implant malfunction	Stop procedure immediately, perform emergency care and call implant supplier before restarting procedure.
8. Electrical shocks to user	Wiring fault	Refer to electrician

## User Care Checklist – Electrosurgery Units / Cautery Machines

<b>Daily</b>	
Cleaning	<ul style="list-style-type: none"><li>✓ Remove any dust / dirt and replace equipment cover</li><li>✓ Remove any tape, paper or foreign body from equipment</li></ul>
Visual checks	<ul style="list-style-type: none"><li>✓ Check all fittings and cables are properly connected</li><li>✓ Check there are no signs of spilled liquids or cable damage</li></ul>
Function checks	<ul style="list-style-type: none"><li>✓ Check foot / probe switch smooth operation.</li><li>✓ Check return plate cable disconnection alarm before use.</li></ul>

<b>Weekly</b>	
Cleaning	<ul style="list-style-type: none"><li>✓ Unplug, clean outside with damp cloth and dry off</li></ul>
Visual checks	<ul style="list-style-type: none"><li>✓ Inspect filters, clean or replace if needed.</li><li>✓ Check footswitch is not damaged and is working properly</li><li>✓ If any plug, cable or socket is damaged, replace</li></ul>
Function checks	<ul style="list-style-type: none"><li>✓ Check proper operation of all controls, indicators and visual displays on the unit.</li><li>✓ If not recently used, check operation on wet soap</li></ul>

<b>Every six months</b>
Biomedical Technician check required

## Chapter 4.7 Endoscopes

### Function

Endoscopy means looking inside the body using an endoscope, an instrument used to examine the interior of a hollow organ or cavity of the body. Endoscopes are inserted directly into the organ.

An endoscope can consist of a rigid or flexible tube, a light delivery system (light source), an optical fibre system, a lens system transmitting the image to the viewer, an eyepiece and often an additional channel to allow entry of medical instruments, fluids or manipulators.

There are many different types of endoscopy, including arthroscopy, bronchoscopy, colonoscopy, colposcopy, cystoscopy, laparoscopy and laryngoscopy.

### How it works

Endoscopes may be rigid or flexible, although most endoscopes in routine use are flexible. Both use lenses, tubes and light to magnify and view the internal structures of the body. Water and air, as well as surgical instruments that may be necessary to take a tissue sample, can also be passed along the hollow centre of the endoscope. The view can be recorded by a camera and displayed on a computer screen.

Rigid endoscopes are usually much shorter than flexible endoscopes. They are often used to look at the surface of internal organs, and may be inserted through a small cut in the skin or a natural orifice. Gas or fluid is sometimes used to move the surface tissues of organs in order to see them more clearly. Rigid endoscopes are commonly used to examine the joints and bladder.

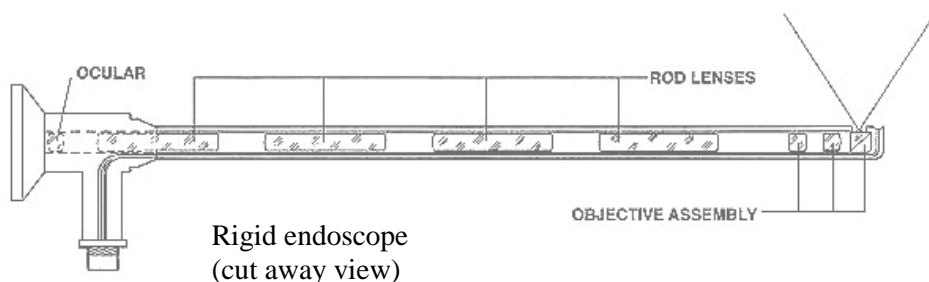
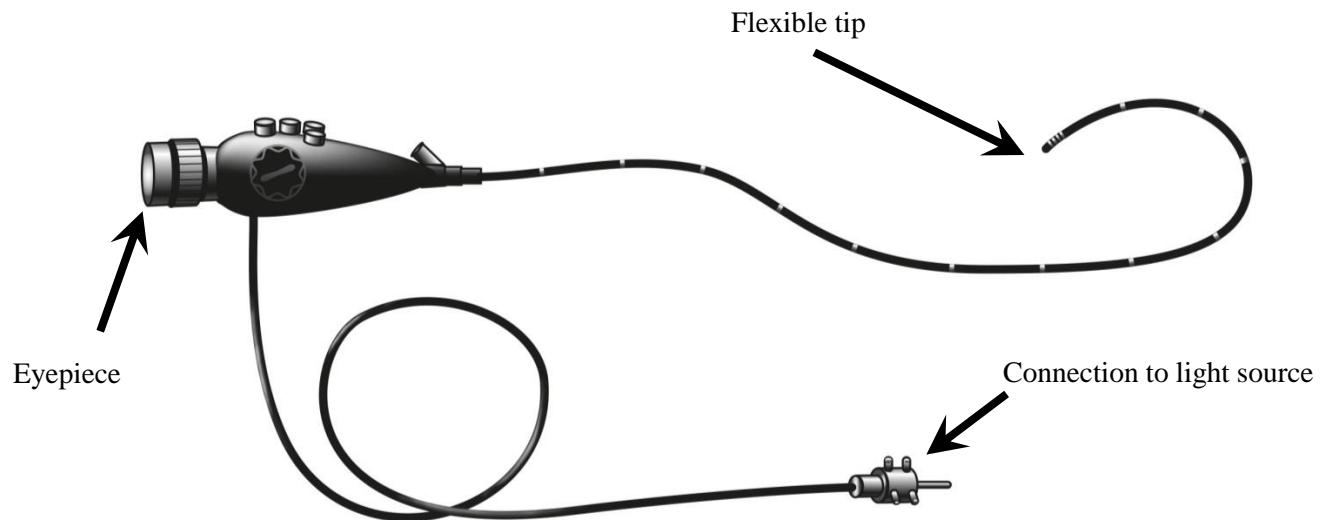

## Troubleshooting – Endoscopes

Fault	Possible Cause	Solution
1. No fluid flow or suction through scope	Blocked air / water nozzle	Press fluid valve and flush Clean and lubricate valve (see user manual) Check tubes are not kinked.
	Loose or damage setscrew	Refer to biomedical technician.
2. Leakage in flexible endoscope	Tears or cut in flexible shaft	Refer to biomedical technician
3. Fluid invasion, e.g. - Image stains - Foggy images - Electrical malfunction	Water or other fluids in dry parts of flexible scope due to holes, tears or improper cleaning.	Perform leak test after every procedure  If any fluid invasion occurs, refer to biomedical technician.
4. Picture is cloudy or with dark spots	Build-up of matter on the distal lens.	Clean the lens with an alcohol wipe.
	Broken fibres in cable	If these significantly affect use, return to manufacturer
5. Cannot freely bend to the degree specified	Over-bending portion of scope. Fluid invasion	Do not force bending. Refer to biomedical technician
6. Instruments do not pass easily through the biopsy / access channel	Damaged forceps and brushes	Flush channel through. Check for burrs and nicks by rubbing a gloved hand over all surfaces of the accessory. Refer to biomedical technician if problem remains
7. Light not functioning	Bulb blown	Replace bulb with correct type
	Fuse blown	Replace fuse with correct rating
	No power from socket	Check power switch is on. Check mains power is present at socket using equipment known to be working. Contact electrician for rewiring if power not present.
8. Electrical shocks	Wiring fault	Refer to electrician

## User Care Checklist – Endoscopes

<b>Daily</b>	
Cleaning	<ul style="list-style-type: none"> <li>✓ Flush, rinse, dry and disinfect endoscope after every use</li> <li>✓ Remove any tape, paper or foreign body from equipment</li> </ul>
Visual checks	<ul style="list-style-type: none"> <li>✓ Check all accessories and fittings are properly connected.</li> <li>✓ Check there are no signs of damage to the flexible tube</li> <li>✓ Store in correct packaging for protection</li> </ul>
Function checks	<ul style="list-style-type: none"> <li>✓ Check operation of controls and tubes before use</li> </ul>

<b>Weekly</b>	
Cleaning	<ul style="list-style-type: none"> <li>✓ Flush, rinse, dry and disinfect endoscope</li> <li>✓ Perform leak test as per manufacturer’s guidelines, making sure water resistant cap is in place</li> <li>✓ Unplug light source, clean with damp cloth and dry off</li> </ul>
Visual checks	<ul style="list-style-type: none"> <li>✓ Inspect optics for cloudiness, foreign bodies or dark spots</li> <li>✓ Check sturdiness of trolley if used</li> <li>✓ If any plug, cable or socket is damaged, replace</li> </ul>
Function checks	<ul style="list-style-type: none"> <li>✓ Check proper operation of all controls, indicators and lamps</li> </ul>

<b>Every six months</b>	
Biomedical Technician check required	

## Chapter 4.8 Incubators (Infant)

### ***Function***

An infant incubator is a closed chamber in which a controlled environment is provided to the premature or critically ill baby. The user can select the appropriate temperature, humidity and oxygen level suitable for the baby.

### ***How it works***

The general principle is that air is processed before it reaches baby. An electric fan draws room air through a bacterial filter which removes dust and bacteria. The filtered air flows over an electric heating element. The filtered and heated air then passes over a water tank where it is moistened. It then flows on to the incubator canopy. The incubator canopy is slightly pressurised. This allows expired carbon dioxide to pass back into the room via the vent holes and most of the air to be re-circulated. It also prevents unfiltered air entering the system.



## Troubleshooting – Incubators (Infant)

Fault	Possible Cause	Solution
1. Incubator is not running	No power from mains socket  Electrical cable fault	Check power switch is on. Replace fuse with correct voltage and current if blown. Check mains power is present at socket using equipment known to be working. Contact electrician for rewiring if power not present.  Try cable on another piece of equipment. Contact electrician for repair if required.
2. Fuse keeps blowing	Power supply or cable fault	Refer to electrician
3. Alarms not working	Alarm battery dead	Replace the battery (if accessible) and recheck. Send for repair if problem remains.
4. Temperature not properly controlled	Incubator placed in direct sunlight or near a draught / fan.  Air leakage or door open  Temperature probe and sensor not working  Fan, filter or air duct problem	Move incubator if placed near heat or draught  Check all seals and doors are tight.  Check the temperature probes and sensor connections. Replace the temperature probe and sensor and recheck.  Call technician if fan not working. Unblock air duct and clean filter if obstructed.
5. Incubator not heating even when the heater lamp is on.	Heating element problem	If accessible, replace heating element. Otherwise refer to technician for repair
6. Electrical shocks	Wiring fault	Refer to electrician immediately



User Care Checklist – Incubators (Infant)

<b>Daily</b>	
Cleaning	<ul style="list-style-type: none"> <li>✓ Wipe dust off exterior</li> <li>✓ Remove any tape, paper or foreign body from equipment</li> </ul>
Visual checks	<ul style="list-style-type: none"> <li>✓ Check all fittings and accessories are mounted correctly</li> </ul>
Function checks	<ul style="list-style-type: none"> <li>✓ Drain off the water tray. Run machine for 30 minutes to dry the tray. Refill tray with sterile water just before re-use.</li> <li>✓ Cover equipment after checks</li> </ul>

<b>Weekly</b>	
Cleaning	<ul style="list-style-type: none"> <li>✓ Unplug, clean outside with damp cloth and dry off</li> <li>✓ Remove any dirt from wheels</li> <li>✓ Wash (or replace) the air filters, dry thoroughly for reuse</li> </ul>
Visual checks	<ul style="list-style-type: none"> <li>✓ Check mains plug screws are tight</li> <li>✓ Check mains cable has no bare wire and is not damaged</li> <li>✓ Check doors, cable and tray. Repair if damaged</li> </ul>
Function checks	<ul style="list-style-type: none"> <li>✓ Check all controls operate correctly</li> <li>✓ Check the readings of thermometer and oxygen sensors change when breathed upon</li> <li>✓ Check any batteries are working properly.</li> </ul>

<b>Every six months</b>	
Biomedical Technician check required	

## Chapter 4.9 Laboratory Equipment

### ***Function***

A modern hospital has a huge variety of equipment designed to assist in diagnosis. Samples are prepared and cleaned using incubators, water baths and centrifuges, while sterilisation might be done with autoclaves or hot air ovens. Analysis is carried out with photometers and colorimeters in even the simplest of laboratories, and the microscope and weighing balance are essential for most laboratory services. For more details on care and maintenance of laboratory equipment, see the WHO publication “Maintenance Manual for Laboratory Equipment”.

### ***How it works***

With only a few exceptions, equipment is powered by electricity. The equipment power supply will run light sources, amplifiers, meters or heaters according to the design and function. All equipment will be dealing with human body samples, usually fluids, so good clinical practice and infection prevention are necessary. The display will be by meter, screen or eye observation, so a clean and comfortable working environment are also required.



## Troubleshooting – Laboratory Equipment

Fault	Possible Cause	Solution
1. Equipment is not running	No power from mains socket	Check power switch is on. Replace fuse with correct voltage and current rating if blown. Check mains power is present at socket using equipment known to be working. Contact electrician for rewiring if power not present.
	Electrical cable fault	Try cable on another piece of equipment. Contact electrician for repair if required.
2. Fuse keeps blowing	Power supply or cable fault	Refer to electrician
3. Equipment not fully operational	Part malfunction	Check controls for correct positioning and operation (refer to user manual)
		Check all bulbs, heaters, thermostats and connectors for function, heating elements for limescale. Repair or replace if necessary.
4. Visibility of sample is poor	Illumination set low	Increase illumination or check bulb wattage.
	Dust or dirt in system	Check screen and surfaces for dirt, cleaning if necessary.
	Mould on eyepiece or sample window	Clean lens as directed in user manual using correct cleaning solution.
5. Fluid leakage	Poor seal	Tighten where leaking. Clean or replace seal.
	Damaged housing	Identify leak and arrange for local repair.
6. Noisy operation	Loose parts	Check rotors etc. are tight and equipment is on level surface with feet adjusted.
	Electrical sparks	Check where burning is visible or audible and replace / repair.
7. Electrical shocks	Wiring fault	Refer to electrician

## User Care Checklist – Laboratory Equipment

### Daily

Cleaning	✓ Wipe dust off exterior and cover equipment after checks
	✓ Remove any tape, paper or foreign body from equipment
Visual checks	✓ Check all fittings and accessories are mounted correctly
	✓ Check there are no cracks in covers or liquid spillages
Function checks	✓ If in use that day, run a brief function check before clinic

### Weekly

Cleaning	✓ Unplug, clean outside with damp cloth and dry off
	✓ Clean any filters or lenses as directed by user manual
Visual checks	✓ Check all screws and parts are fitted tightly
	✓ Check mains plug screws are tight
	✓ Check mains cable has no bare wire and is not damaged
Function checks	✓ Check any paper, oil, batteries etc. required are sufficient
	✓ Check all switches and door / lid locks operate correctly

### Every six months

Biomedical Technician check required

## Chapter 4.10 Lamps

### ***Function***

There are many kinds of sources of light used in medicine. This chapter deals with large lights for operating theatres or delivery suites, ultraviolet or infrared phototherapy units, ophthalmic slit lamps, handheld and head worn lamps for ENT clinics, dental curing lights and domestic torches. However, the principles here will help in the user care of any kind of light source. Endoscopes are dealt with separately in chapter 4.7.

### ***How it works***

Each type of lamp will have a power source with switch and a bulb. Some will also have controls for the brightness or focus of the light, while others will also have lenses to direct the light where required. Some lights operate off mains electricity, while others use batteries instead. Some lights have both, using the batteries for back-up power in case of mains supply failure. Electric bulbs and batteries have limited life and will need regular checking. Bulbs can last from hundreds of hours operation to thousands of hours. Some equipment, e.g. UV phototherapy units, will indicate when bulbs need replacing. Turning bulbs on and off frequently can reduce the bulb life. A stock of spares should be kept of all the correct voltages and wattages (ratings) of parts.

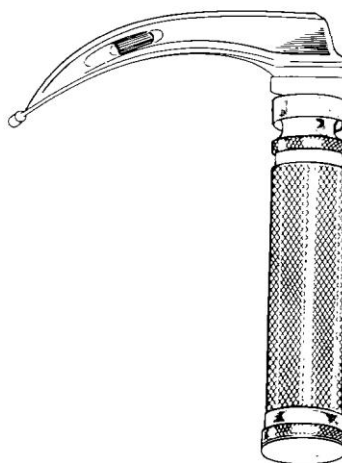
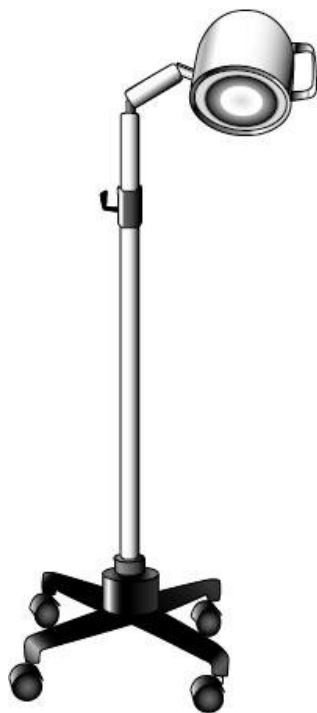

## Troubleshooting – Lamps

Fault	Possible Cause	Solution
1. No light or 'power on' visible	No power at mains socket	Check power switch is on. Replace fuse with correct rating of voltage and current if blown. Check mains power is present at socket using equipment known to be working. Contact electrician for rewiring if power not present.
	Dead battery	Charge or replace batteries
	Blown bulb	Replace bulb with correct voltage and wattage
	Battery leakage	Remove batteries (if accessible), clean battery terminals and replace with new battery
	Electrical cable fault	Try cable on another piece of equipment. Contact electrician for repair if required.
	Internal wiring fault	Refer to electrician
2. Fuse / bulb keeps blowing	Fuse or bulb is wrong rating	Replace with correct rating
	Power supply or cable fault	Refer to electrician
3. Light cannot be made bright enough	Dirt on lens or tube	Clean area with dry, clean cotton
	Poor power supply	Check power line or replace batteries
	Wrong bulb rating	Check bulb rating is correct
	Control malfunction	Refer to electrician
4. Electrical shocks	Wiring fault	Refer to electrician

## User Care Checklist – Lamps

<b>Daily</b>	
Cleaning	✓ Wipe dust off exterior and cover equipment after checks
Visual checks	✓ Check all fittings and accessories are mounted correctly
	✓ Check there are no cracks in glass / covers or liquid spillages
Function checks	✓ If in use that day, run a brief function check before clinic

<b>Weekly</b>	
Cleaning	✓ Unplug, clean outside with damp cloth and dry off
	✓ Clean any filters, covers and battery compartment
	✓ Remove dirt from wheels/any moving part
Visual checks	✓ Check all screws and parts are fitted tightly
	✓ Check mains plug screws are tight
	✓ Check mains cable has no bare wire and is not damaged
Function checks	✓ Check all switches operate correctly
	✓ Remove or charge batteries if out of use

<b>Every six months</b>	
Biomedical Technician check required	

## Chapter 4.11 Nebulizers

### ***Function***

A nebulizer is a device used to administer medication in the form of a mist inhaled into the lungs. Nebulizers are commonly used for treatment of cystic fibrosis, asthma and other respiratory diseases. The reason for using a nebulizer for medicine to be administered directly to the lungs is that small aerosol droplets can penetrate into the narrow branches of the lower airways. Large droplets would be absorbed by the mouth cavity, where the clinical effect would be low.

### ***How it works***

The common technical principle for all nebulizers is to use oxygen, compressed air or ultrasonic power as means to break up medical solutions or suspensions into small aerosol droplets. These are passed for direct inhalation either through the mouthpiece of the device or a hose set. Gas powered devices use a small pump to force the gas through the solution and will normally have a filter for the gas inlet. Ultrasonic devices use a small crystal to generate vibrations in the solution that cause droplets to break off.

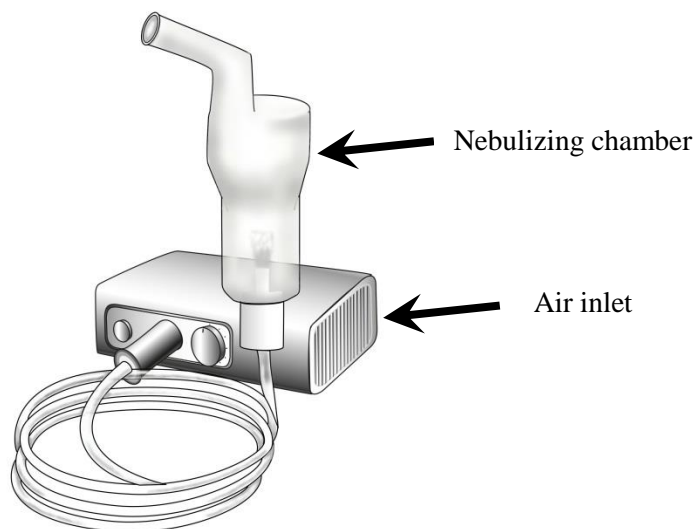



## Troubleshooting – Nebulizers

Fault	Possible Cause	Solution
1. Equipment is not working	No power from mains socket	Check power switch is on. Replace fuse with correct voltage and current if blown. Check mains power is present at socket using equipment known to be working. Contact electrician for rewiring if power not present.
	Electrical cable fault	Try cable on another piece of equipment. Contact electrician for repair if required.
2. Machine is working but flow is absent or low	Filter is blocked	Clean filter
	Pipe is twisted or nebulizer chamber / mouthpiece is blocked.	Connect pipe properly, clean chamber / mouthpiece
	Worn out pump tubing	Replace tubing
	Compressor (or air source) is broken obstructed or leaking	Remove any blocking material or call biomedical technician to fix the problem.
3. Inadequate nebulizing amount	Output adjustment not correctly set	Adjust output as directed in user manual
	Mouthpiece cracked	Replace mouthpiece
	Internal fault	Refer to biomedical technician
4. Electrical shocks or fuse keeps blowing	Wiring fault	Refer to electrician

## User Care Checklist – Nebulizers

<b>Daily</b>	
Cleaning	<ul style="list-style-type: none"><li>✓ Clean and sterilize mouthpiece and medicine chamber</li><li>✓ Wipe dust from machine and replace cover after checks</li></ul>
Visual checks	<ul style="list-style-type: none"><li>✓ Check all parts are present and tightly fitted</li><li>✓ Check all moving parts move freely, all holes are unblocked</li></ul>
Function checks	<ul style="list-style-type: none"><li>✓ Check the whole system function before use</li></ul>

<b>Weekly</b>	
Cleaning	<ul style="list-style-type: none"><li>✓ Unplug, clean outside with damp cloth and dry off</li><li>✓ Clean filter and air chamber of compressor</li></ul>
Visual checks	<ul style="list-style-type: none"><li>✓ Check chamber, body and tube seals, replace if cracked</li><li>✓ If mains plug, cable or socket are damaged, replace them</li></ul>
Function checks	<ul style="list-style-type: none"><li>✓ When next used, check for adequate nebulization.</li><li>✓ Check compressor fan is working without excessive noise.</li></ul>

<b>Every six months</b>
Biomedical Technician check required

## Chapter 4.12 Oxygen Concentrators

### Function

An oxygen concentrator draws in room air, separates the oxygen from the other gases in the air and delivers the concentrated oxygen to the patient. When set at a rate of two litres per minute, the gas that is delivered by the concentrator is more than 90% oxygen. It is used for situations where bottled gas supply is impractical or expensive, and can be used by patients in the hospital or the home.

### How it works

Atmospheric air consists of approximately 80% nitrogen and 20% oxygen. An oxygen concentrator uses air as a source of oxygen by separating these two components. It utilizes the property of zeolite granules to selectively absorb nitrogen from compressed air. Atmospheric air is gathered, filtered and raised to a pressure of 20 pounds per square inch (psi) by a compressor. The compressed air is then introduced into one of the canisters containing zeolite granules where nitrogen is selectively absorbed leaving the residual oxygen available for patient use. After about 20 seconds the supply of compressed air is automatically diverted to the second canister where the process is repeated enabling the output of oxygen to continue uninterrupted. While the pressure in the second canister is at 20 psi the pressure in the first canister is reduced to zero. This allows nitrogen to be released from the zeolite and returned into the atmosphere. The zeolite is then regenerated and ready for the next cycle. By alternating the pressure between the two canisters, a constant supply of oxygen is produced and the zeolite is continually being regenerated. Individual units have an output of up to five litres per minute with an oxygen concentration of up to 95%.

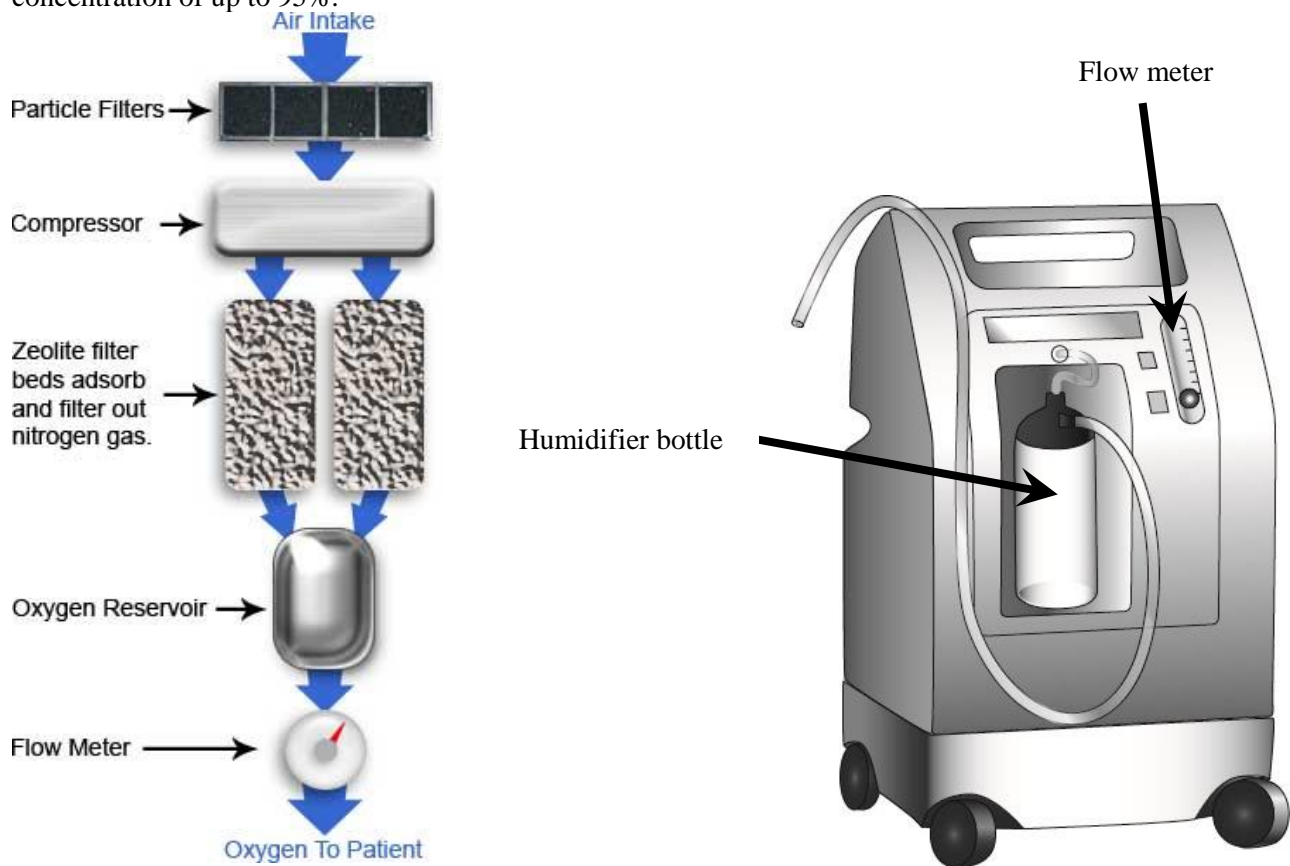

## Troubleshooting – Oxygen Concentrators

Fault	Possible Cause	Solution
1. Unit not operating, power failure alarm sounds	<p>No power from mains socket</p> <p>Concentrator circuit breaker has been set off.</p> <p>Electrical cable fault</p>	<p>Check mains switch is on and cable inserted. Replace fuse with correct voltage / current if blown. Check mains power is present at socket using equipment known to be working. Contact electrician for repair if required.</p> <p>Press reset button if present</p> <p>Try cable on another piece of equipment. Contact electrician for repair if required.</p>
2. Unit not operating, no power failure alarm	Alarm battery dead	Replace battery (if accessible) and test as above
3. No oxygen flow	<p>Flow not visible</p> <p>Tubes not connected tightly</p> <p>Water or matter blocking the oxygen tubing</p> <p>Blocked flow meter or humidifier bottle</p>	<p>Place tube under water and look for bubbles. If bubbles emerge steadily, gas is indeed flowing</p> <p>Check tubing and connectors are fitted tightly</p> <p>Remove tubing, flush through and dry out before replacing</p> <p>Replace meter / bottle or refer to biomedical technician</p>
4. Temperature light or low oxygen alarm is on	Unit overheated or obstructed	<p>Remove any obstruction caused by drapes, bedspread, wall, etc. Clean filters.</p> <p>Turn unit off and use backup oxygen system. Restart unit after 30 minutes.</p> <p>Call biomedical technician if problem not solved.</p>
5. Electrical shocks	Wiring fault	Refer to electrician

## User Care Checklist – Oxygen Concentrators

<b>Daily</b>	
Cleaning	<ul style="list-style-type: none"><li>✓ Remove any dust / dirt with damp cloth and dry off</li><li>✓ Fill humidifier bottle up to marker with clean distilled water</li></ul>
Visual checks	<ul style="list-style-type: none"><li>✓ Check screws, connectors, tubes and parts are tightly fitted</li></ul>
Function checks	<ul style="list-style-type: none"><li>✓ Check oxygen flow before clinically required</li></ul>

<b>Weekly</b>	
Cleaning	<ul style="list-style-type: none"><li>✓ Wash filter in warm water and dry. Replace if damaged</li><li>✓ Clean humidifier bottle thoroughly and dry off</li><li>✓ Remove dirt from wheels/any moving part</li></ul>
Visual checks	<ul style="list-style-type: none"><li>✓ Replace humidifier bottle if covered with limescale.</li><li>✓ If mains plug, cable or socket are damaged, replace</li></ul>
Function checks	<ul style="list-style-type: none"><li>✓ Run machine for two minutes and check no alarms occur</li><li>✓ Check (see bubbles) that flow rate varies with flow control</li></ul>

<b>Every six months</b>	
Biomedical Technician check required	

## Chapter 4.13 Oxygen Cylinders and Flowmeters

### **Function**

Medical gases such as oxygen, nitrous oxide etc. are intended for administration to a patient in anaesthesia, therapy or diagnosis. An oxygen cylinder is a cylindrically shaped metal container used to store oxygen that has been compressed to a very high pressure. Oxygen cylinders, which come in different sizes, are usually black coloured with a white top; in some cases, it may be a small cylinder that is entirely black. The black colour helps to differentiate it from other substances that are stored in similar containers. Cylinders are fitted with customized valves (either 'bullnose' or 'pin index' type) with valve guards, which are opened with valve keys.

A flowmeter is an instrument used to measure the flow rate of a liquid or a gas. In healthcare facilities, gas flowmeters are used to deliver oxygen at a controlled rate either directly to patients or through medical devices. Oxygen flowmeters are used on oxygen tanks and oxygen concentrators to measure the amount of oxygen reaching the patient or user. Sometimes bottles are fitted to humidify the oxygen by bubbling it through water.

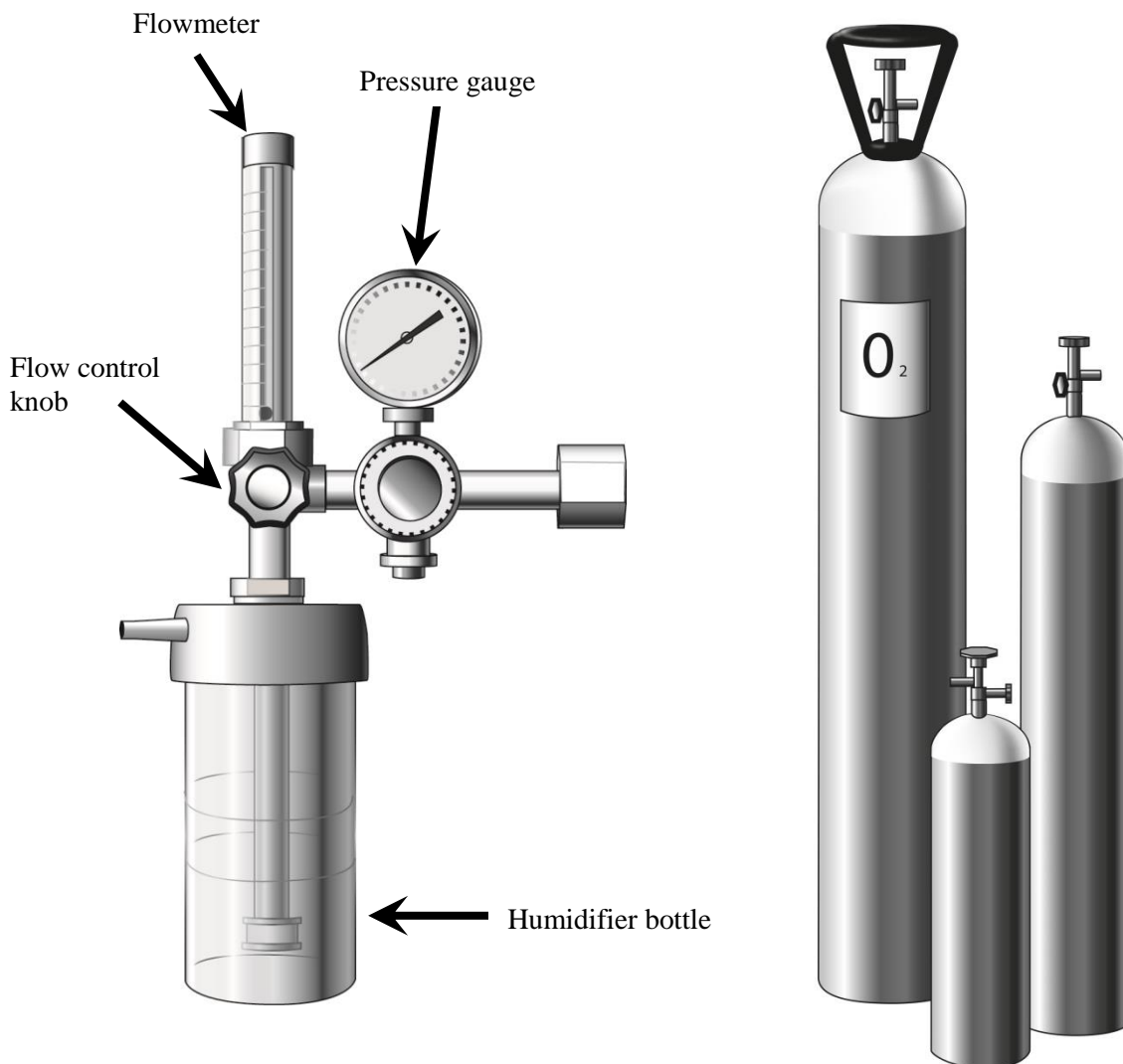

## Troubleshooting – Oxygen Cylinders and Flowmeters

Fault	Possible Cause	Solution
1. No oxygen is flowing	Empty cylinder	Replace cylinder
	Flow meter knob or cylinder valve is closed.	Open valves, then check flow meter registers flow
	Faulty regulator	Close all valves and replace regulator
2. Leakage from cylinder or flowmeter	Cylinder is not connected to pressure regulator properly	Tighten all fittings
	Faulty or missing washer between regulator and cylinder	Replace washer
	Flowmeter seal damaged or loose	Tighten flowmeter
	Cylinder faulty	Label 'Faulty' and return to manufacturer
3. Leakage cannot be located	Leakage too small to be heard	Apply detergent solution (NOT oily soap) to joints. Bubbles will show at leak point. Clean/replace washer and tighten at that joint.
4. Flowmeter ball not moving, yet oxygen is flowing	Faulty flow meter	Close all valves, disconnect flowmeter and clean inside. Reconnect and test.
		If problem persists, replace flowmeter
5. Pressure gauge does not show pressure, yet oxygen is flowing	Faulty pressure gauge	Refer to biomedical technician for replacement

## User Care Checklist – Oxygen Cylinders and Flowmeters

<b>Daily</b>	
Cleaning	<ul style="list-style-type: none"><li>✓ Ensure delivery tubes and masks are sterile</li><li>✓ If humidifier bottle is used, refill with clean water</li></ul>
Visual checks	<ul style="list-style-type: none"><li>✓ Check cylinder is correct type and marked oxygen</li><li>✓ Check all parts are fitted tightly and correctly</li></ul>
Function checks	<ul style="list-style-type: none"><li>✓ Before use, ensure cylinder is filled and flow is present</li><li>✓ Close cylinder valve and fasten cylinder safely after each use.</li></ul>

<b>Weekly</b>	
Cleaning	<ul style="list-style-type: none"><li>✓ Clean cylinder, valve and flowmeter with damp cloth</li></ul>
Visual checks	<ul style="list-style-type: none"><li>✓ Check for leakage: hissing sound or reduction in pressure</li><li>✓ Check cylinder mount or chain is secure</li></ul>
Function checks	<ul style="list-style-type: none"><li>✓ Remove valve dust with brief, fast oxygen flow</li><li>✓ Check flow can be varied using flow control</li></ul>

<b>Every six months</b>
Biomedical Technician check required



## Chapter 4.14 Pulse Oximeters

### ***Function***

A pulse oximeter is a device that non-invasively monitors the oxygen saturation of a patient's blood. It measures the amount of oxygen in a patient's arterial blood during operations and diagnosis. This level of oxygen, or 'oxygen saturation' is often referred to as  $SpO_2$ , measured in %, and this is displayed on the pulse oximeter. A pulse oximeter also displays pulse rate.

### ***How it works***

The coloured substance in blood, haemoglobin, is a carrier of oxygen and the absorption of light by haemoglobin varies with the amount of oxygenation. Two different kinds of light (one visible, one invisible) are directed through the skin from one side of a probe, and the amount transmitted is measured on the other side. The machine converts the ratio of transmission of the two kinds of light into a % oxygenation. Pulse oximeter probes can be mounted on the finger or ear lobe.



## Troubleshooting – Pulse Oximeters

Fault	Possible Cause	Solution
1. Equipment is not running	No power from mains socket	Check power switch is on. Replace fuse with correct voltage and current if blown. Check mains power is present at socket using equipment known to be working. Contact electrician for rewiring if power not present.
	Battery (if present) is discharged	Recharge or replace battery
	Electrical cable fault	Try cable on another piece of equipment. Contact electrician for repair if required.
2. SpO <sub>2</sub> or pulse rate not displayed or unstable	Probe is not mounted correctly	Connect probe and cable properly
	Probe not able to read through dirt, nail polish, etc.	Remove grease, dirt, nail polish and clean probe
	Patient movement	Request patient to remain still
	Patient's SpO <sub>2</sub> value is too low to be measured	Further clinical examination of patient. Resite probe if necessary
	Internal malfunction	Call biomedical technician.
3. "Probe off" displayed on screen	Probe is not connected properly	Connect the sensor
	The connection between the probe and oximeter is loose	Refer to biomedical technician for repair
4. "Error" displayed on screen	Faulty probe or control circuit	Refer to biomedical technician
5. Continuous alarm sounds	Alarm limits set too low or high	Set appropriate alarm limits
	Power disconnected	Connect power cable
	Internal malfunction	Refer to biomedical technician
6. Electrical shocks	Wiring fault	Refer to biomedical technician immediately

## User Care Checklist – Pulse Oximeters

### Daily

- |                 |   |
|-----------------|---|
| Cleaning        | <ul style="list-style-type: none"><li>✓ Remove any dust / dirt</li><li>✓ Remove any tape, paper or foreign body from equipment</li><li>✓ Clean probe with alcohol wipe after each use</li></ul> |
| Visual checks   | <ul style="list-style-type: none"><li>✓ Check all parts are present and connected</li><li>✓ Check cables are not twisted and remove from service if any damage is visible</li></ul>             |
| Function checks | <ul style="list-style-type: none"><li>✓ Check operation on healthy subject before use</li><li>✓ Store probe and cable carefully, replace equipment cover</li></ul>                              |

### Weekly

- |                 |  |
|-----------------|--|
| Cleaning        | <ul style="list-style-type: none"><li>✓ Unplug, clean outside with damp cloth and dry off</li></ul>  |
| Visual checks   | <ul style="list-style-type: none"><li>✓ Check all screws and parts are fitted tightly</li><li>✓ If plug, cable or socket are damaged, replace</li></ul>    |
| Function checks | <ul style="list-style-type: none"><li>✓ Check operation of all lights, indicators and visual displays</li><li>✓ Check probe disconnection alarm.</li></ul> |

### Every six months

Biomedical Technician check required

## Chapter 4.15 Refrigerators and Freezers

### **Function**

Both refrigerators and freezers keep medical supplies or blood products cool in order to prolong their life. Refrigerators can keep the contents between +2°C and +6°C, but are normally set around +4°C. They are used for laboratory reagents, vaccines and red blood cells. Freezers generally operate below -15°C, and blood plasma freezers are required to keep contents at -40°C. They need to maintain these temperatures whatever the outside temperature.

### **How it works**

Refrigeration works by using an energy source to move heat from inside the unit to the outside environment. The energy source is usually electricity, but kerosene is still used where mains electricity or solar power is not available. For transport boxes, ice packs (formed in a freezer) keep the contents cool until a refrigerator or freezer is reached again. A thermostat sets the temperature required, and the energy source is activated when the inside temperature goes above this point. The electric models will normally need a voltage stabilizer with cut-out delay, to protect the system.

The contents of the refrigerator or freezer are kept on shelves, in boxes or in baskets to make removal easy and to allow the cooling air to circulate freely.

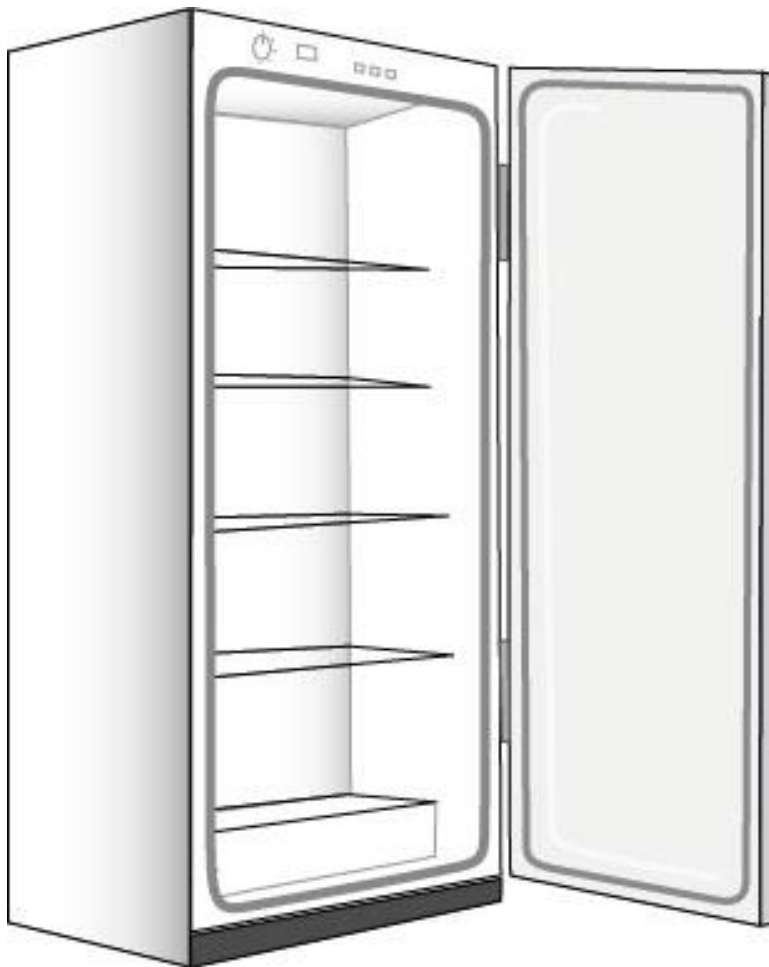

Troubleshooting – Refrigerators and Freezers

Fault	Possible Cause	Solution
1. Unit not operating, power failure. Alarm sounds (if present).	No power from mains socket	Check mains switch is on and plug inserted. Replace fuse with correct voltage/current if blown. Check mains power is present at socket using equipment known to be working. Contact electrician for repair if required.
	The unit's circuit breaker has been set off.	Press reset button if present.
	Electrical cable fault	Check power cable is not damaged. Contact electrician for repair if required.
2. Unit not operating, no power failure alarm	Alarm battery dead	Replace battery (if accessible) and test as above.
3. Compressor runs continuously  or  Temperature too warm	Door open	Reduce time door is open. Check seal and replace if damaged.
	Air circulation poor	Provide good clearance round unit for compressor cooling. Ventilate room.
	Ice build up	Remove contents to alternate unit. Defrost unit according to manufacturer instructions.
	Thermostat fault	Call technician for repair.
4. Noisy operation	Floor not level or not firm	Move unit to firm, level floor. Adjust feet to make unit level.
	Tray or shelf vibrating	Adjust tray position
	Internal fault	Call technician for repair
5. Temperature too cold	Temperature setting has been changed by accident	Check temperature setting
	Thermostat fault	Call technician for repair
6. Electrical shocks	Wiring fault	Refer to electrician

## User Care Checklist – Refrigerators and Freezers

<b>Daily</b>	
Cleaning	✓ Remove any dust / dirt with damp cloth and dry off
Visual checks	✓ Check lid is tightly closed
Function checks	✓ Ensure power light is on when in operation

<b>Weekly</b>	
Cleaning	<ul style="list-style-type: none"><li>✓ Clean shelves, drawers, door seal and inside walls with a damp cloth</li><li>✓ Remove dirt and dust from compressor with soft, dry brush or cloth</li></ul>
Visual checks	<ul style="list-style-type: none"><li>✓ Check all screws, tubes and parts tightly fitted</li><li>✓ If mains plug, cable or socket are damaged, replace</li><li>✓ Check contents are not too tightly packed</li><li>✓ (Kerosene units) Check fuel level and clean flue</li></ul>
Function checks	✓ Ensure any internal lighting and alarms operate

<b>Every six months</b>	
Technician check required	

## Chapter 4.16 Scales

### ***Function***

Measuring patient weight is an important part of monitoring health as well as calculating drug and radiation doses. It is therefore vital that scales continue to operate accurately. They can be used for all ages of patient and therefore vary in the range of weights that are measured. They can be arranged for patients to stand on, or can be set up for weighing wheelchair bound patients. For infants, the patient can be suspended in a sling below the scale or placed in a weighing cot on top of the scale.

### ***How it works***

Mechanical scales have a spring deflected by patient weight. The spring pushes a pointer along a display or rotates a disc to indicate weight. Electronic scales have a sensor that bends under patient weight and the circuitry converts this to displayed digits.

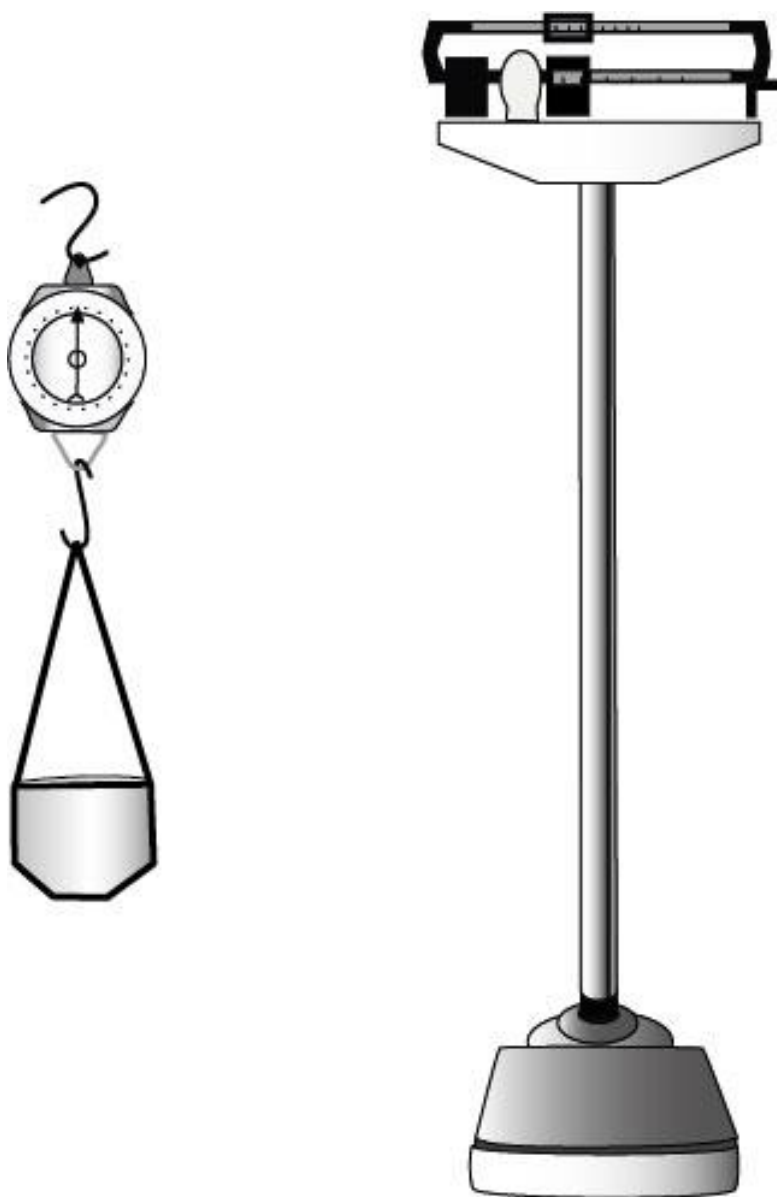

## Troubleshooting – Scales

Fault	Possible Cause	Solution
1. Zero point cannot be set	Scales are not level	Set scales on level ground and retest
	Zero control broken or internal part jammed	Send for repair
2. Movement is stiff or jerky	Dirt lodged inside	Remove any visible dirt or foreign body and retest
	Internal blockage	Send for repair
3. Reading is inaccurate	Zero not properly set	Reset zero and retest
	Calibration error	Recalibrate or send for repair
4. Electronic display is blank	Battery / power failed	Replace battery (if accessible) or power supply and retest
	Internal error	Send for repair



## User Care Checklist – Scales

<b>Daily</b>	
Cleaning	<ul style="list-style-type: none"><li>✓ Wipe off dust and dirt from exterior</li><li>✓ Clear away any dirt or hair on controls and feet</li></ul>
Visual checks	<ul style="list-style-type: none"><li>✓ If bent, cracked or damaged, send for repair</li></ul>
Function checks	<ul style="list-style-type: none"><li>✓ Check zero at start of day and before each patient</li><li>✓ Replace dust cover after checks</li></ul>

<b>Weekly</b>	
Cleaning	<ul style="list-style-type: none"><li>✓ Clean exterior with damp cloth and dry off</li><li>✓ Send for repainting if any exposed or rusted metal</li></ul>
Visual checks	<ul style="list-style-type: none"><li>✓ Check all screws and parts are fitted tightly</li></ul>
Function checks	<ul style="list-style-type: none"><li>✓ Check reading is accurate using a known weight</li><li>✓ Send for repair if inaccurate or sticking</li><li>✓ Replace battery or charge if display shows low battery</li></ul>

<b>Every six months</b>
Biomedical Technician check required

## Chapter 4.17 Sphygmomanometers (B.P. sets)

### **Function**

Blood pressure is an indicator of several diseases as well as of general health. It is an easy screening test using simple equipment. A sphygmomanometer can be used to measure the blood pressure at the high point (systolic) and low point (diastolic) of the cardiac pressure cycle. Pressure is usually measured using a cuff on the upper arm.

### **How it works**

The cuff on the arm is inflated until blood flow in the artery is blocked. As the cuff pressure is decreased slowly, the sounds of blood flow starting again can be detected. The cuff pressure at this point marks the high (systolic) pressure of the cycle. When flow is unobstructed and returns to normal, the sounds of blood flow disappear. The cuff pressure at this point marks the low (diastolic) pressure.

Pressure can be measured using a meter with dial (aneroid type), a mercury column or an electronic display. The sounds are normally detected using a stethoscope, but some electronic equipment uses a different, automatic technique with pressure sensors. The two methods do not always give the same results and the stethoscope method is generally seen to be more accurate for all types of patient.

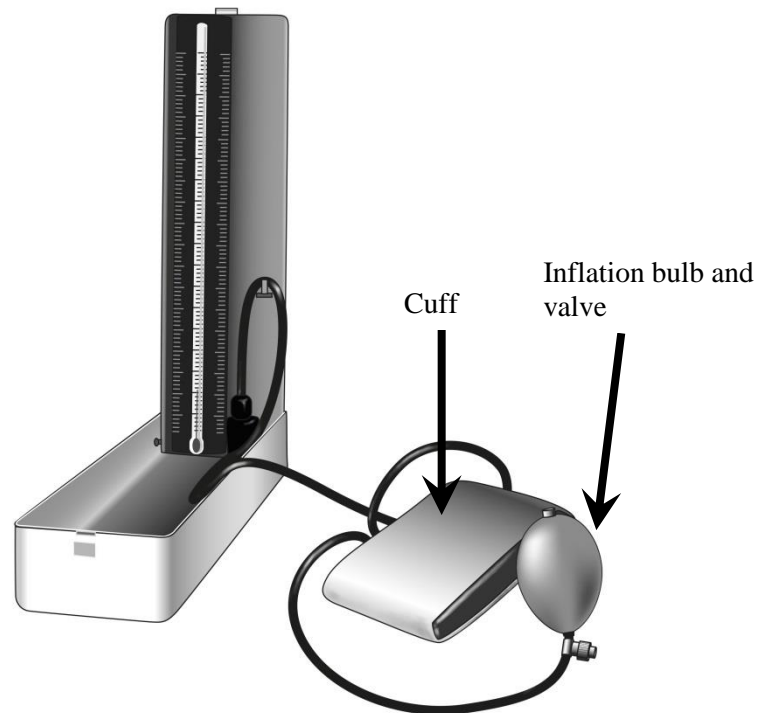
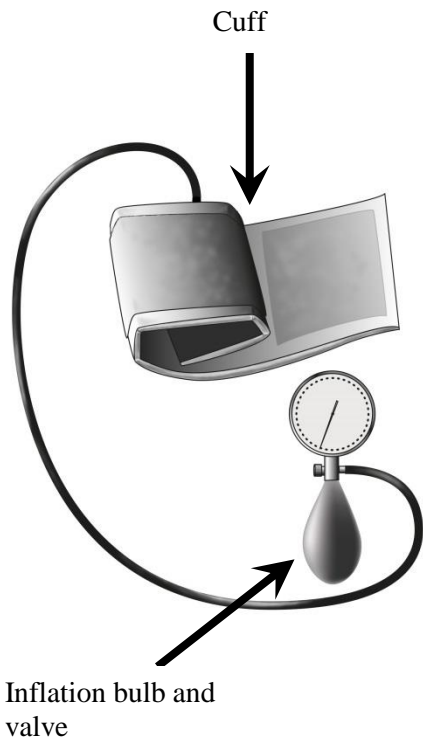

## Troubleshooting – Sphygmomanometers (B.P. sets)

Fault	Possible Cause	Solution
1. Mercury leakage OR Mercury not at zero level	Mercury leakage or overfilling	Refer to technician for correction
2. Mercury is dirty	Oxidation of mercury	Refer to technician for cleaning
3. Pressure does not increase easily OR Pressure increases after inflation	Valve or tube blockage	Remove and clean all valves and tubes. Reassemble and test
4. Aneroid instrument does not return to zero	Zero setting has moved	Rotate collar on base until zero setting achieved and tighten. If still malfunctioning, refer to technician
5. Pressure does not remain steady	Leakage of air	Isolate leak by closing off parts of tubing. Replace leaking section and retest

## User Care Checklist – Sphygmomanometers (B.P. sets)

<b>Daily</b>	
Cleaning	✓ If mercury is spilled, seal unit and send to technician
Visual checks	✓ Ensure all parts are present and are tightly fitted
	✓ Check display is zero when cuff deflated
Function checks	✓ Before use, check pressure rises and returns to zero
	✓ Check equipment is safely packed

<b>Weekly</b>	
Cleaning	✓ Remove all dust and dirt with damp cloth or by hand
Visual checks	✓ Remove or replace any cracked rubber parts
Function checks	✓ Check correct operation of inflation bulb and valves
	✓ Remove any batteries if not in use for more than one month
	✓ Inflate to 200 mmHg and check leakage is not faster than 2 mmHg in 10 seconds

<b>Every six months</b>	
✓	Biomedical Technician check required
✓	Check calibration of aneroid devices against mercury device

## Chapter 4.18 Stethoscopes

### **Function**

A stethoscope is used to listen to sounds within the body. These might be sounds generated by breathing, coughing, blood flow or the stomach. The sounds are picked up and transmitted to the ears of the medical staff for diagnosis.

### **How it works**

A membrane on the stethoscope chestpiece picks up the vibrations caused by internal sounds and transmits them to the stethoscope tube. The sounds pass up the tube through the earpiece to the user. The stethoscope chestpiece also contains an open bell which is used to pick up lower frequency sounds. The head picks up the sound from a wide area so it sounds loud to the user. Care must therefore be taken not to hit or shout into the stethoscope while in use.

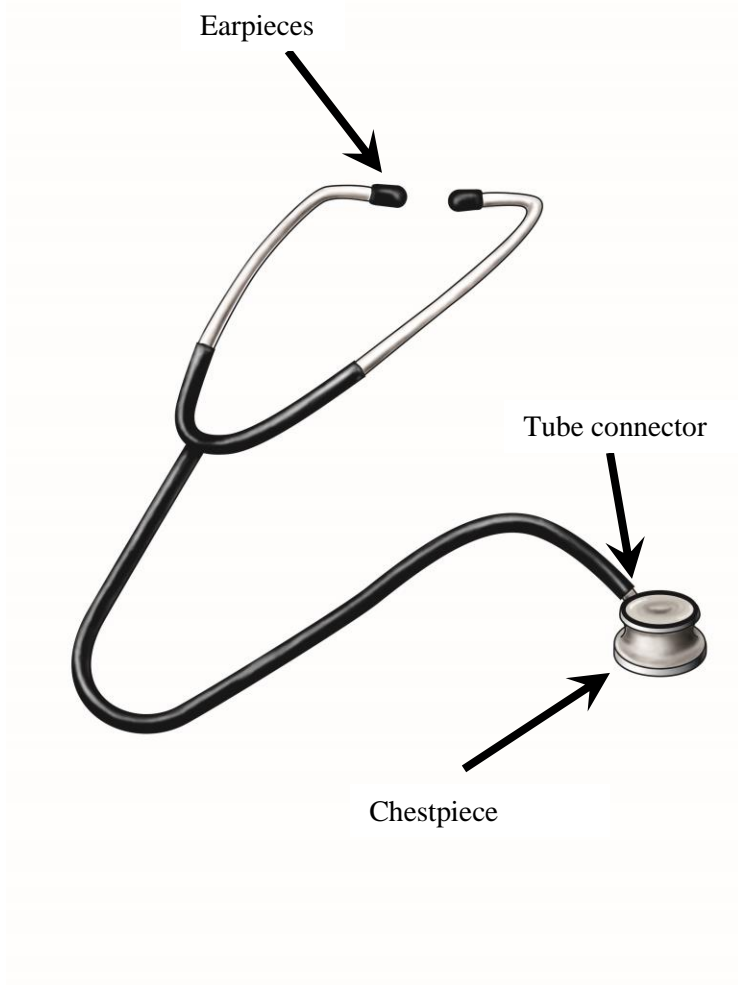

## Troubleshooting – Stethoscopes

Fault	Possible Cause	Solution
1. Faint or no sound heard	Leakage or blockage	Remove all parts and check for leakage and blockage. Water or blowing air can be used to flush tubes through. Assemble and retest
2. Tube connector does not stay in chestpiece	Broken locking mechanism	Refer to technician for repair
3. Parts damaged or faulty	Broken part	Replace with part taken from other units

## User Care Checklist – Stethoscopes

### Daily

- |                 |   |   |
|-----------------|---|---|
| Cleaning        | ✓ | Remove any dirt visible                             |
| Visual checks   | ✓ | Check all parts are present and tightly fitted      |
| Function checks | ✓ | Tap chestpiece gently before use to check operation |
|                 | ✓ | Check equipment is safely packed                    |

### Weekly

- |                 |   |  |
|-----------------|---|--|
| Cleaning        | ✓ | Remove all dirt with damp cloth or by hand             |
|                 | ✓ | Remove earpieces and clean inside with warm water      |
| Visual checks   | ✓ | Remove or replace any cracked rubber parts             |
|                 | ✓ | Replace membrane if broken                             |
| Function checks | ✓ | Check tube connector rotates easily within chestpiece  |
|                 | ✓ | Check sound can be heard from both sides of chestpiece |

### Every six months

Biomedical Technician check required

## Chapter 4.19 Suction Machines (Aspirators)

### **Function**

Suction machines (also known as aspirators) are used to remove unwanted fluid from body cavities. They are found in operating theatres, delivery suites, ENT and emergency departments. Smaller specialised suctions are used in dental departments.

### **How it works**

Suction is generated by a pump. This is normally an electrically powered motor, but manually powered versions are also often found. The pump generates a suction that draws air from a bottle. The reduced pressure in this bottle then draws the fluid from the patient via a tube. The fluid remains in the bottle until disposal is possible. A valve prevents fluid from passing into the motor itself. Often a second bottle is used, so that suction can still occur while a bottle is being cleaned. It also gives another stage of protection from liquid ingress to the motor.

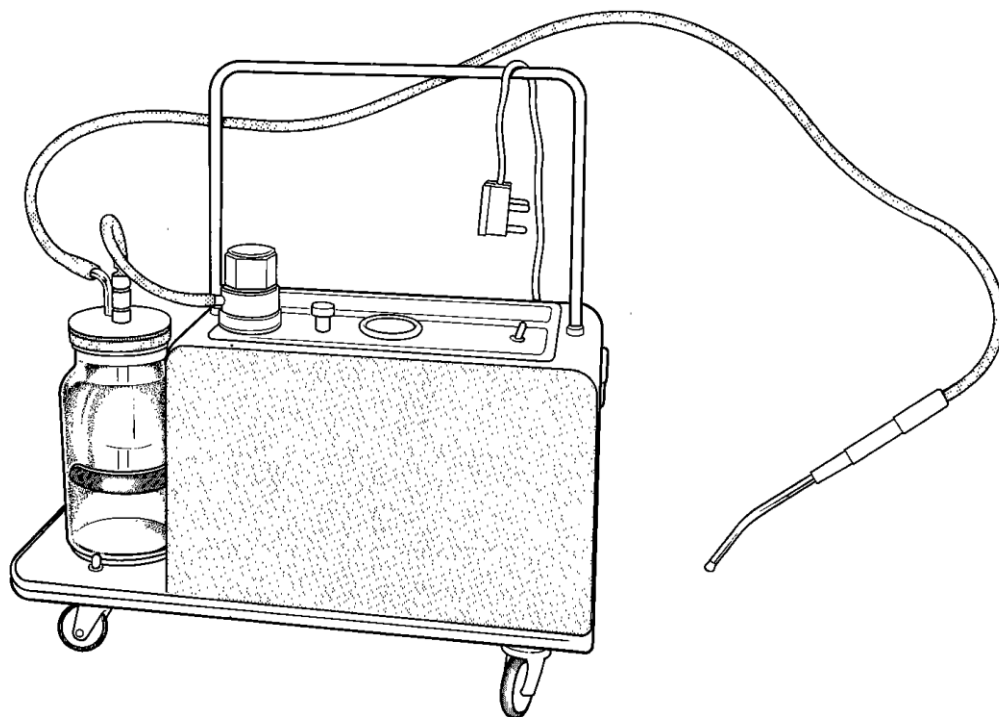



## Troubleshooting – Suction machines

Fault	Possible Cause	Solution
1. Machine is not running	No power from mains socket	Check power switch is on. Check mains power is present at socket using equipment known to be working. Contact electrician for rewiring if power not present.
	Fuse blown	Check for leaks or wire causing fuse to blow and correct this. Replace fuse with correct voltage and current rating. Test operation.
	Electrical cable fault	Try cable on another piece of equipment. Contact electrician for repair if required.
	Internal wiring or switch fault	Refer to electrician
2. Poor fluid flow, pressure gauge low	Tube /seal / bottle leaking or disconnected	Close different tubes by bending. When pressure gauge changes, leakage point has been passed. Replaced damaged tube or seal.
	Air outlet valve blocked	Clean outlet valve
	Control valve stuck	Operate control valve through full range. Send for repair if stuck
	Internal or control error	Refer to technician
3. Poor fluid flow, pressure gauge high	Blocked filter or tube	Disconnect each tube one at a time. When gauge changes, blockage has been passed. Replace filter or unblock tube.
4. Filter discoloured	Floating valve broken	Change filter, clean or replace floating valve
5. Electrical shocks	Wiring fault	Refer to electrician
6. Manual suction is jammed	Internal slider stuck	Refer to technician for greasing

### User Care Checklist – Suction Machines

<b>Daily</b>	
Cleaning	<ul style="list-style-type: none"><li>✓ Wipe dust off exterior and cover equipment after checks</li><li>✓ Wash bottle and patient tubing with sterilising solution</li></ul>
Visual checks	<ul style="list-style-type: none"><li>✓ Check all fittings and accessories are mounted correctly</li><li>✓ Check filter is clean</li></ul>
Function checks	<ul style="list-style-type: none"><li>✓ If in use that day, run a brief function check before clinic</li></ul>

<b>Weekly</b>	
Cleaning	<ul style="list-style-type: none"><li>✓ Unplug, clean outside with damp cloth and dry off</li><li>✓ Wipe round bottle seal with damp cloth, replace if cracked</li><li>✓ Remove dirt from wheels / moving parts</li></ul>
Visual checks	<ul style="list-style-type: none"><li>✓ Check parts are fitted tightly and replace any cracked tubes</li><li>✓ Check mains plug screws are tight</li><li>✓ Check mains cable has no bare wire and is not damaged</li></ul>
Function checks	<ul style="list-style-type: none"><li>✓ Check all switches and vacuum control operate correctly</li></ul>

<b>Every six months</b>	
Biomedical Technician check required	

## Chapter 4.20 Tables – (Operating Theatre and Delivery)

### ***Function***

Tables are required to hold the patient in a position comfortable both for themselves and for medical staff during procedures. They can include dedicated supports for head, arms and legs and often have movable sections to position the patient appropriately. They are made both with wheels and on static platforms and can have movements powered by electric motors, hydraulics or simply manual effort. They can be found in emergency departments, operating theatres and delivery suites.

### ***How it works***

Where the table has movement, this will be enabled by unlocking a catch or brake to allow positioning. Wheels have brakes on the rim or axle of the wheel, while locks for moving sections will normally be levers on the main table frame. Care should be taken that the user knows which lever applies to the movement required, as injury to the patient or user may otherwise result. The table will be set at the correct height for patient transfer from a trolley then adjusted for best access for the procedure.



## Troubleshooting – Operating Theatre and Delivery Tables

Fault	Possible Cause	Solution
1. Table cannot be relocated	Wheels jammed  Electric motor not operational (electrically driven table)	Clean wheels, remove obstruction  Check power to table Replace fuse if blown If problem persists, refer to technician
2. Table section or body cannot be moved	Lock or lever is jammed  No power to electric table  No oil in hydraulic table	Clean jammed part, remove rust and dirt, lightly oil and replace  Check correct switch is used Check power and fuses  Refill hydraulic oil if needed Check no leakage occurs
3. Oil leakage from hydraulic table	Oil leakage	Locate leak and block it. Clear spillage. Refer to technician.
4. Electric shocks	Wiring fault	Refer to technician immediately

## User Care Checklist – Operating Theatre and Delivery Tables

<b>Daily</b>	
Cleaning	<ul style="list-style-type: none"><li>✓ Clean, dry and disinfect all parts</li><li>✓ Remove all paper, tape and foreign matter</li></ul>
Visual checks	<ul style="list-style-type: none"><li>✓ Check all parts are present and tightly fitted</li><li>✓ Replace mattress if worn or damaged</li><li>✓ Check no oil is leaking from hydraulics</li></ul>
Function checks	<ul style="list-style-type: none"><li>✓ Check essential movements before use</li></ul>

<b>Weekly</b>	
Cleaning	<ul style="list-style-type: none"><li>✓ Clean and dry table, base and underneath table and base</li><li>✓ Wipe off any escaped oil or grease from joints</li></ul>
Visual checks	<ul style="list-style-type: none"><li>✓ Fully inspect mattress and table for signs of wear</li><li>✓ Replace any worn items and send for repair</li></ul>
Function checks	<ul style="list-style-type: none"><li>✓ Check wheel brakes function and wheels rotate</li><li>✓ Ensure all moving parts can move, applying grease if needed</li></ul>

<b>Every six months</b>	
Technician check required	

## Chapter 4.21 Ultrasound Machines

### **Function**

Diagnostic ultrasound machines are used to give images of structures within the body. This chapter does not deal with other kinds of machine (e.g. therapeutic and lithotripsy). The diagnostic machine probes, which produce the ultrasound, come in a variety of sizes and styles, each type being produced for a particular special use. Some require a large trolley for all the parts of the unit, while the smallest come in a small box with only a audio loudspeaker as output. They may be found in cardiology, maternity, outpatients and radiology departments and will often have a printer attached for recording images. Unlike X-rays, ultrasound poses no danger to the human body.

### **How it works**

The ultrasound probe contains a crystal that sends out bursts of high frequency vibrations that pass through gel and on through the body. Soft tissue and bone reflect echoes back to the probe, while pockets of liquid pass the ultrasound straight through. The echoes are picked up and arranged into an image displayed on a screen. The machine offers a number of processing options for the signal and image and also allows the user to measure physical features displayed on the screen. This requires the machine to incorporate a computer.

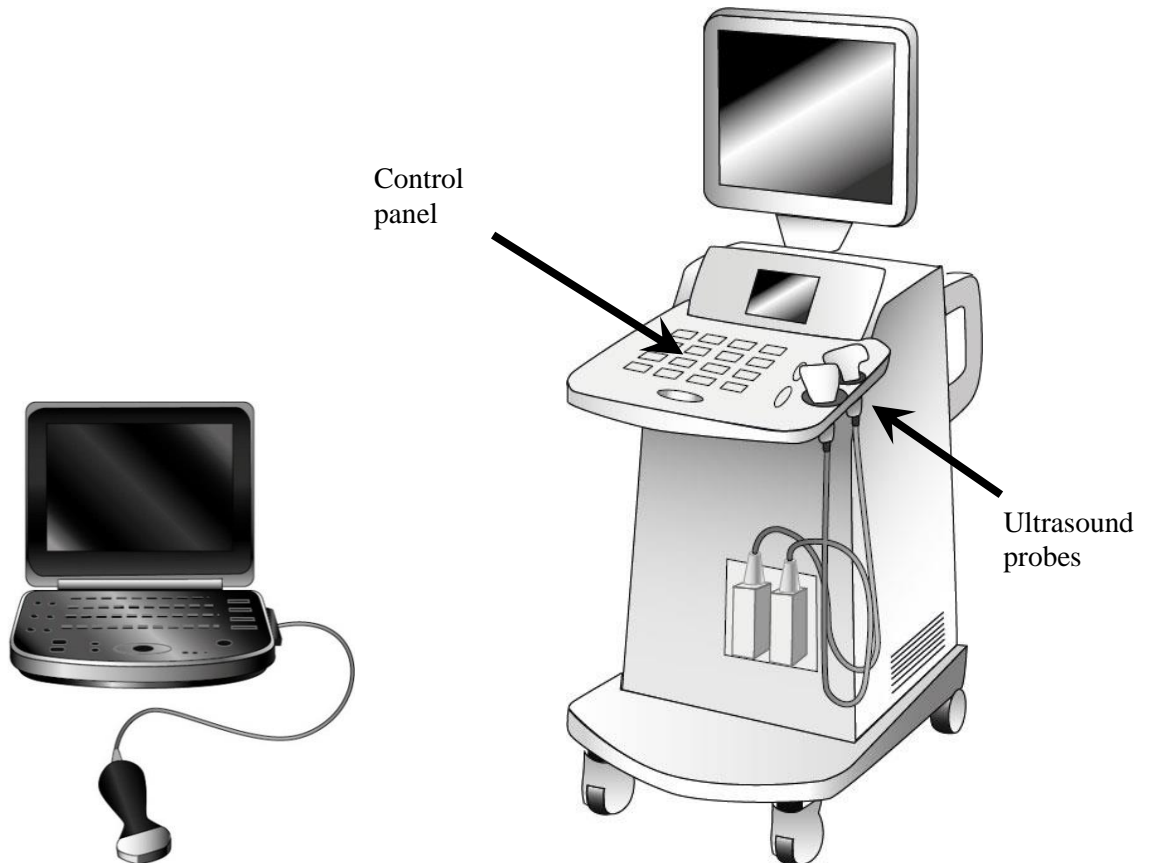

## Troubleshooting – Ultrasound Machines

Fault	Possible Cause	Solution
1. Equipment is not running	No power from mains socket  Electrical cable fault	Check power switch is on. Replace fuse with correct voltage and current if blown. Check mains power is present at socket using equipment known to be working. Contact electrician for rewiring if power not present.  Try cable on another piece of equipment. Contact electrician for repair if required.
2. Fuse keeps blowing	Power supply or cable fault	Refer to electrician
3. Probe head damaged or noisy	Possible internal fault	Exchange probe Send for testing and repair
4. Image quality poor	Gel insufficient  Controls set incorrectly  Mains voltage is too low  Probe / display problem	Use more ultrasound gel  Check controls for correct positioning and operation (refer to user manual)  Use voltage stabiliser  Refer to biomedical technician
5. Display / computer error	Software fault	Turn machine off and restart. If problem persists, refer to biomedical technician
6. Electrical shocks	Wiring fault	Refer to electrician

User Care Checklist – Ultrasound machines

<b>Daily</b>	
Cleaning	<ul style="list-style-type: none"><li>✓ Wipe dust off exterior and cover equipment after checks</li><li>✓ Remove any tape, paper or foreign body from equipment</li><li>✓ Wipe probe with alcohol-free tissue or cloth</li></ul>
Visual checks	<ul style="list-style-type: none"><li>✓ Check all fittings and accessories are mounted correctly</li><li>✓ Check cables are not twisted and probe is safely stored</li></ul>
Function checks	<ul style="list-style-type: none"><li>✓ If in use that day, run a brief function check before clinic</li></ul>

<b>Weekly</b>	
Cleaning	<ul style="list-style-type: none"><li>✓ Unplug, clean outside / wheels / rear with damp cloth, dry off</li><li>✓ Remove, clean and dry external filter if present</li></ul>
Visual checks	<ul style="list-style-type: none"><li>✓ Check mains plug screws are tight</li><li>✓ Check mains cable has no bare wire and is not damaged</li></ul>
Function checks	<ul style="list-style-type: none"><li>✓ If machine has not been in use, run and test briefly</li></ul>

<b>Every six months</b>	
Biomedical Technician check required	



## Chapter 4.22 X-Ray Machines

### **Function**

X-Ray machines are used for imaging bones and hard tissues and diagnosing fractures, joint defects, choked lungs etc. Sometimes contrast agents are also used to highlight any defects in the abdomen under X-rays.

### **How it works**

X-rays are high energy electromagnetic waves. The transformer produces a high voltage that directs electrons onto a target in the machine head. X-rays are produced by the target and are directed into beams by a collimator towards the human body. Soft body tissue absorbs less X-rays, i.e., passes more of the radiation, whereas bone and other solids prevent most of the X-rays from going through. A photographic film or electronic sensor displays how much X ray has passed through, forming an image of the interior of the body. Bone appears nearly white, because few X-rays strike the corresponding part of the film, leaving it largely unexposed; soft tissue allows much more radiation to pass through, darkening the film in those places.

Users must ensure proper radiation safety protocols and supervision are in place. See Chapter 9 for suitable references and further information.

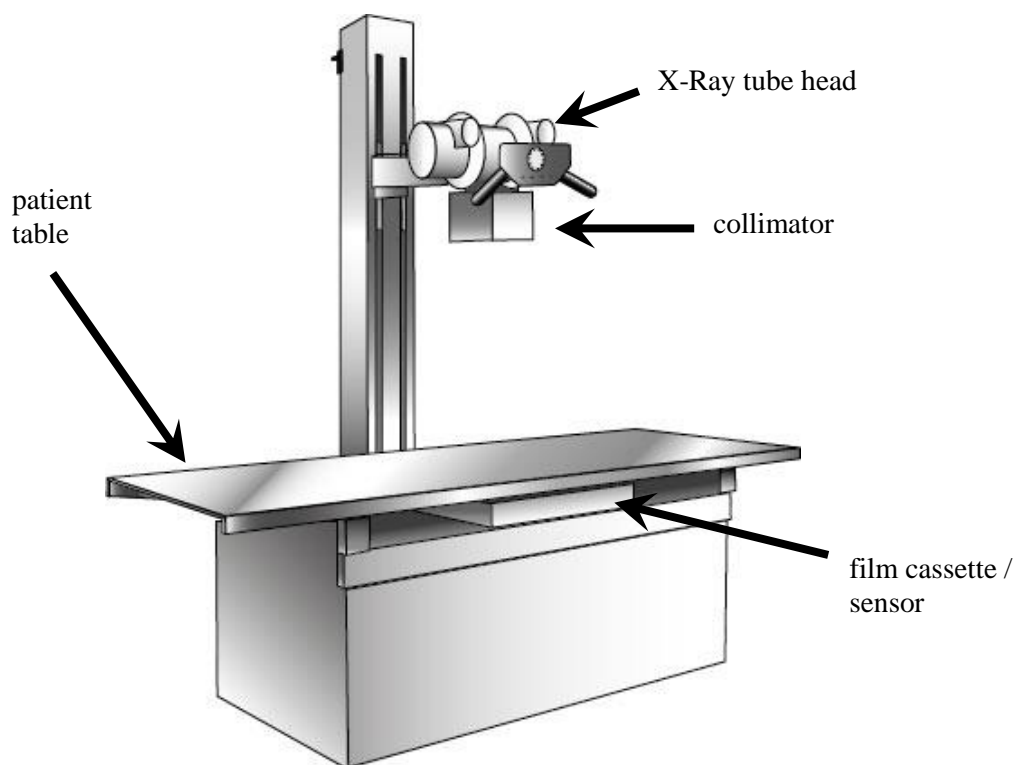

(control panel and transformer not shown)

## Troubleshooting – X-Ray Machines

Fault	Possible Cause	Solution
1. X-Ray unit does not switch on.	Mains power not connected	Check the machine is plugged into the mains socket and that all switches are on. Replace fuse with correct voltage and current if blown. Check mains power is present at socket using equipment known to be working. Contact electrician for rewiring if power not present.
2. X-Ray machine not exposing, even when power is on.	Safety interlock is on Exposure switch cable problem Internal error	Check safety locks, all switches Check for any loose connection Refer to biomedical technician
3. Poor X-Ray image quality	X-Ray tube problem	Check X-ray film cassette is correct type and is undamaged  Refer to biomedical technician / medical physicist
4. The table does not move.	Table motor or cable problem. Safety switch or fuse problem Control circuit problem	Check all cable connections Check relevant fuse or switch Refer to biomedical technician
5. Electrical shocks	Wiring fault	Refer to biomedical technician immediately

## User Care Checklist – X-Ray Machines

<b>Daily</b>	
Cleaning	<ul style="list-style-type: none"><li>✓ Clean dust from the unit with a dry cloth</li><li>✓ Remove any tape, paper or foreign body from equipment</li></ul>
Visual checks	<ul style="list-style-type: none"><li>✓ Check all parts are present and connected</li><li>✓ Check cables are not twisted and remove from service if any damage is visible</li></ul>
Function checks	<ul style="list-style-type: none"><li>✓ Switch on power and check all indicators function</li></ul>

<b>Weekly</b>	
Cleaning	<ul style="list-style-type: none"><li>✓ Clean all dust and dirt from the X-Ray machine and room</li></ul>
Visual checks	<ul style="list-style-type: none"><li>✓ If any plug, cable or socket is damaged, refer to biomedical technician</li><li>✓ Check all knobs, switches and wheels operate properly</li><li>✓ Check lead aprons for any defects</li><li>✓ Check table, cassette holder and grids for smooth movement</li></ul>
Function check	<ul style="list-style-type: none"><li>✓ If machine has not been in use, wear lead apron and check whether exposure indicator lights on switch operation</li><li>✓ Check collimator bulb, replace with correct type if needed</li></ul>

<b>Every six months</b>	
Biomedical Technician check required	

## Chapter 5. Handling Waste

In a hospital, many type of waste are generated which may be classified as follows: General waste or scrap, Sewage waste, Biomedical waste, Chemical waste, Radioactive waste, Electronic or e-Waste.

Most hospitals and countries will have clear guidelines on handling waste, particularly sharps and clinical waste. Make sure those guidelines are clearly understood and followed in your workplace. The following summaries may be helpful when training others or explaining to patients and visitors. The checklist on page 77 can be laminated and displayed where waste is generated or disposed.

### 1. **General waste or Scrap**

General waste or scrap is mostly bio-degradable or recyclable. Items such as building materials, iron, material made from wood, etc. may be recycled and even generate a small amount of income for the hospital. Waste food or cardboard may be kept separate and rotted down to use as compost, although care must be taken to protect this from scavenging animals.

### 2. **Sewage waste**

Sewage waste is drained from toilets, sinks and baths and should be kept separate from hospital sluices. It will be dealt with using soak-away pits or municipal sewage treatment.

All the other types of waste will need special consideration.

### 3. **Biomedical waste**

Biomedical waste is all waste tissue and body fluids, including clinical items contaminated with these. Hospital management must take steps to segregate, manage and safely dispose of this waste. Equipment users must be aware of the systems that exist for this and follow local procedures. Sharps (needles, cannulas etc.) must be disposed of in a secure, separate container that is sealed when full and processed according to local waste disposal guidelines. This would normally involve a secure, high temperature incinerator.

**Most importantly, users must keep biomedical waste separate from other waste. Waste tissue, body fluid and contaminated clinical items should never be accessible to people or animals.**

### 4. **Chemical waste**

Chemical waste includes mercury, refrigerants such as CFCs, solvents, batteries and asbestos materials. It is the responsibility of hospital management to ensure that hazardous chemical waste is not mixed with other waste and is disposed of safely, not via informal waste collectors. Consult your local waste management guidelines to see what materials are included in this category. Chemical waste normally requires specialist companies for safe processing and disposal.

**Most importantly for users, chemical waste should be stored separately and safely and never be burned.**

## 5. **Radioactive waste**

Radioactive waste, or equipment still capable of producing radiation, may be found in various items in or disposed from a radiology or oncology department. Radioactive material can take a very long time to become safe so should always remain in its protective container.

**No user should ever be involved with radioactive waste without the involvement of the relevant national authority and/or a qualified Medical Physicist. It should be labelled with the sign below.**



## 6. **E-waste**

Electronic waste, also known as e-Waste or Waste Electrical and Electronic Equipment (WEEE) consists of any broken or unwanted electrical or electronic appliance, including of course many medical devices. Many components of such equipment are considered toxic and are not biodegradable, such as printed circuit boards, wires, plastic material, cathode ray tubes (screens), liquid crystal displays, batteries and glass tubes.

E-Waste is a safety issue. If disposed improperly, it poses a potential threat to human health, groundwater and the environment. E-Waste accounts for 40% of the lead and 75% of the heavy metals, such as silver and gold, found in landfills. However, these can be recycled from it. As with chemical waste, e-waste normally requires specialist companies for safe processing and disposal, and the institution can earn revenue through this channel.

### 6.1. **How to manage e-waste**

Medical equipment and measuring instruments such as BP and multiparameter monitors, pulse oximeters, analyzers and ultrasounds contain wires, printed circuit boards, displays, heavy metals such as mercury, batteries, plastic material etc. which do not rot away. After condemnation of this equipment, it is vital to dispose of them properly. Only use accredited scrap dealers for e-waste disposal, as health hazards will result from improper disposal or burning. Users must make other colleagues and suppliers aware of the potential hazards of the waste, as they will have a working knowledge of the contents of the equipment.

## Handling Waste

### Do's

- ✓ Keep biomedical and chemical waste separate from other waste
- ✓ Segregate e-waste including batteries at a place set aside for the purpose
- ✓ Use protective gloves / goggles or boots while dealing with hazardous products
- ✓ Call manufacturer / supplier or authorized agency to dispose of your e-waste
- ✓ Procure material either having no or reduced toxicity / hazardous content
- ✓ Ensure hospital management is aware of waste rules & regulations
- ✓ Follow waste rules & regulations

### Don'ts

- ✗ Do not be involved with radioactive waste without Medical Physics
- ✗ Do not throw used / discarded electronic items into the general waste bin
- ✗ Do not burn batteries, plastic or wires to dispose of them
- ✗ Do not sell your e-waste to informal middlemen or scrap dealers

## Chapter 6. Installation of equipment

Many common problems with medical equipment can be avoided if it is properly installed. The aim of this chapter is to assist those responsible for receiving and checking equipment when it arrives. If the right equipment arrives in working order with the right parts and manuals then a long and useful life is more likely.

### 1. Roles and responsibilities

Each person in the chain of equipment supply has a particular role and responsibility to fulfil. This applies right from when the need for new equipment is identified to the time when it is used. The following should be used to remind each of their responsibilities and to check their performance.

Specifier	-	Make sure the specification is clear and thorough
Purchaser	-	Select, order and pay correctly, inform receiver of dates and details
Supplier	-	Check supply against specification, install on time, provide training
Carrier	-	Inform receiver before delivery, deliver safely and completely
Receiver	-	Prepare site for installation, check delivery against specification
Local technical staff	-	Ensure equipment is correctly installed, learn maintenance checks required
Stores	-	Ensure equipment is complete, report to purchaser, enter into inventory
User	-	Ensure installed in the right place, check function, get and use user manuals

### 2. Checklist

When equipment arrives, it will be necessary to record the fact and to check that everything has been supplied that was ordered. It will also be necessary to check that the equipment is supplied in the right way. The following list will help to record all details, and on the following page a single sheet of checks can be copied or printed for each item of equipment to ensure correct installation is carried out.

INVENTORY NUMBER ..... EQUIPMENT LOCATION .....

ACCEPTANCE DATE ..... WARRANTY EXPIRY DATE .....

MAINTENANCE CONTRACT WITH .....

EQUIPMENT TYPE .....

NAME OF EQUIPMENT .....

TYPE/MODEL .....

ORDER NUMBER ..... SERIAL NUMBER .....

COST ..... DATE RECEIVED .....

MANUFACTURER ..... SUPPLIER/AGENT .....

ADDRESS ..... ADDRESS .....

.....

PHONE ..... PHONE .....

ACCEPTANCE CHECKS

DELIVERY

	Yes / done	No / not done	Corrected if applicable
a) Representative of supplier present?			
b) Correct number of boxes received?			
c) After unloading, are boxes intact?			
d) If damaged, has this been stated on the delivery note and senior management informed?			

UNPACKING (refer to invoices, shipping documents and original specification)

	Yes / done	No / not done	Corrected if applicable
a) Is the equipment intact and undamaged?			
b) Equipment complete as ordered?			
c) User/operator manual as ordered?			
d) Service/technical manual as ordered?			
e) Accessories and consumables as ordered?			
f) Spare parts as ordered?			

INSTALLATION (refer to manuals)

	Yes / done	No / not done	Corrected if applicable
a) Was installation carried out satisfactorily?			
b) Were all parts present and correctly fitted?			
c) Were technical staff present as learners?			
d) Was the equipment demonstrated as fully working?			
e) Were staff trained in operation of the equipment?			



## Chapter 7. Disposal of equipment

Healthcare institutions must ensure that there are proper procedures in place for condemnation and disposal of equipment that is unserviceable or that is no longer required. This will take old and potentially unsafe equipment out of service, make sure hazardous materials are properly treated and make storage space available. The local health authorities will have details of the procedures and regulations relating to this subject.

Disposal of equipment allows better planning for replacements, release of storage space, upgrading of technology and allows surplus equipment to be used elsewhere.

### **1. Equipment may be declared surplus, obsolete or unserviceable if it is:**

- Surplus to Requirement
  - Where a surplus piece of equipment remains serviceable, management should be informed. It may be decided to store the equipment, auction it or use it elsewhere.
- Unserviceable or unreliable
  - If equipment cannot be repaired (either no parts available or not economical to repair) or it cannot be maintained properly it should be scrapped and replaced.
- Obsolete
  - When equipment is not usable because parts are out of date or the clinical technique is no longer recommended it should be scrapped.
- Damaged through negligence or abuse
  - Where abuse of equipment is suspected, this should be reported to management and the equipment taken out of use
- Beyond its prescribed life period
  - Such equipment should be reported to management and the condemnation committee. They should take into account any period of storage in addition to use, examine the condition of the equipment to see whether the item could be put to further use and if not they will declaring the item obsolete/surplus or unserviceable as appropriate.

### **2. The Condemnation Committee**

The condemnation committee should have several members including one nominee from Finance department. Once they have passed equipment for disposal, a report will be prepared. In order to ensure unwanted items of equipment do not cause unnecessary waste of space, it is important that equipment disposal is done as quickly as possible but not later than six months after the decision for disposal.

### **3. User responsibilities in equipment disposal**

- Keep management informed of equipment status
  - e.g. report when parts are replaced, report when equipment is unreliable
- Be aware of hazards involved when equipment is disposed
  - e.g. warn of the presence of mercury, asbestos etc
- Assist in planning for replacements
  - e.g. comment on helpful or unhelpful features or suppliers
- Keep the asset register up to date
  - e.g. report when equipment arrives new or is replaced
- Request regular maintenance work if it is delayed
  - e.g. send reminders to service / maintenance group when work is due
- Inform maintenance department of any issue as soon as possible
  - e.g. report promptly any work done or spares required

## Chapter 8. Basics of electrical safety

If it is misused or poorly maintained, electrical equipment can be the cause of injury, death or fire. If it is well maintained, electrical equipment can save lives, improve the quality of lives and reduce capital expenditure. Electrical equipment and the electrical connections that supply power to it should always therefore be treated with respect and care.

Careful consideration should always be given to the placing of equipment. Damp conditions should be avoided and equipment should be positioned in a dry, clean, well-ventilated area on a solid, level base. Equipment should be as near as possible to the electrical supply and extension leads should be discouraged.

Since most problems in this area occur with the plugs, sockets and cables supplying electrical power, this chapter mainly focuses on safe use and maintenance of these.

### 1. Socket outlets and plugs

- A convenient and safe socket outlet should be available.
- Socket outlets should be at least 2 m from a sink or wash basin.
- The socket outlet should be adequate for the electrical capacity for the equipment.
- There should be proper earthing in the sockets.
- Plugs should match the socket outlets.



### 2. Wiring of sockets and plugs

The wiring of a plug is colour coded to help guard against electrical accidents. Colour codes normally found are as follows

- Phase (or Live) – Red or Brown (in the US: Black)
  - This carries the electrical drive current from the supplier to the equipment. It is the most dangerous line. Only qualified staff should work with this.
- Neutral – Black or Blue (in the US: White)
  - This returns the current to the supplier. It should not be connected to Earth.
- Earth (or Ground) – Green OR Green with Yellow lines
  - This is used for safety and protection. If equipment is housed in a metal case, the earth line will generally be connected to the case. The earth line in a socket is connected to a pipe or plate buried in the ground.

Notes on earthing:

- The earthing will depend upon the type of equipment being used:
  - If there are only two wires in the power cable, no earth connection is required
  - If the cable fitted has three conductors then equipment needs to be earthed properly
- Always make sure that the earth wire is longer than the other two so that if the cable is accidentally pulled out of the plug, the earth wire is the last wire to become disconnected

### 3. Sizes and types of sockets and plugs

The current rating (i.e. the amount and size of equipment they can supply) is measured in Amperes, written 'A'. The rating and size of normally found plugs and sockets are:

- For low power operations      5 Amperes      – small size
- For large power applications      15 Amperes      – large size

Mains electricity comes at a specified voltage and is measured in Volts, written 'V'. The voltage may be 220-240 V or in other countries it may be 110V. It is very important to make sure your equipment matches the local voltage. Mains electricity is delivered at a specific frequency, measured in Hertz, written 'Hz'. Mains electricity many countries is at 50 Hz, while in others it is 60 Hz. In general, equipment is not as sensitive to frequency difference as it is to voltage, but it should not be used with a frequency that is not stated on its ratings.

A guide to the different plugs and sockets throughout the world can be found at [www.iec.ch/worldplugs](http://www.iec.ch/worldplugs)



The type A American 2-flat pin plug (15A, 125V) is used in the Northern Pacific Islands. The type C European 2-pin plug and electrical outlet (2.5A, 230V), popularly known as the Europlug, likewise does not use earthing. Type D 3-round pin plug (5A, 250V) is used in India, Nepal, Sri Lanka and Namibia, while type I Australian 2-flat pin plug (10A, 240V) with an earthing pin is used in the Southern Pacific Islands.

**It is very important to use the correct kind of plug and socket together. If they are not properly combined, not only is there a danger of using the wrong voltage but there may be unsafe sparks and exposed metal.**

### 4. Mains cables

Electricity is carried to the equipment through the mains cable. Points to be aware of are:

- No bare metal or internal coloured wire should be visible – the plastic insulation is there for safety
- Cable should not be repaired with insulating tape – water can still get inside
- Long flexible leads are dangerous – leads should be as short as possible
- The cable, plug and socket should never be allowed to get wet – water can conduct electricity

### 5. Fuses

Fuses are used as protection. If the current through them is greater than their specified rating, they blow. This breaks the circuit and stops the current, making the equipment safe. Points of safety regarding fuses are:

- Always use the correct rating of fuse – voltage V (volts) and current A (amperes)
- Always use the correct size of fuse – keep the old one to check against
- NEVER replace the fuse with bare wire – it will not be safe
- Circuit breakers are fuses that have buttons or switches for reset – they do not normally need replacing

### Troubleshooting – Electrical Safety

Fault	Possible Cause	Solution
1. Equipment is not running	No power from mains socket	Check power switch is on. Replace fuse with correct voltage and current rating if blown. Check mains power is present at socket using equipment known to be working. Contact electrician for rewiring if power not present.
	Electrical cable fault	Try cable on another piece of equipment. Contact electrician for repair if required.
	Internal problem	Refer to biomedical technician
2. Fuse or circuit breaker blows a second time after replacement	Internal equipment fault	Refer to electrician or biomedical technician
3. Coloured or metal wire visible in cable, socket or plug	Insulation damaged	Remove item and refer to electrician for repair. DO NOT cover with tape.
4. Cracks visible in socket or plug	Damaged cover	Remove item and refer to electrician for repair. DO NOT cover with tape.
5. Electrical shocks	Wiring fault	Refer to electrician

### ***Examples of electrical safety issues***



Damaged cable grip

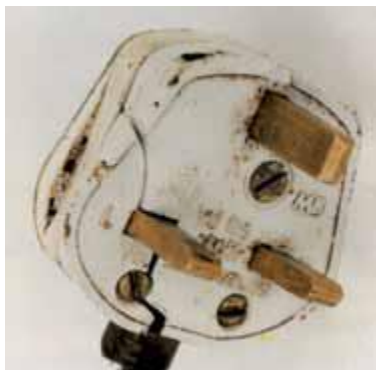

Cracked casing



Damaged cable sheath

## User Care Checklist – Electrical Safety

<b>Weekly Department Checklist</b>	
Cleaning	<ul style="list-style-type: none"><li>✓ Clean dust and liquid off with a DRY cloth</li><li>✓ Remove tape, oil and dirt from all cables, plugs and sockets</li></ul>
Visual checks	<ul style="list-style-type: none"><li>✓ Remove any cracked connectors or cables from service</li><li>✓ Check for and report any damaged room wiring or fittings</li><li>✓ Check for and report any signs of burning, melting or sparks</li><li>✓ Untangle all cables and store carefully</li></ul>
Function checks	<ul style="list-style-type: none"><li>✓ Report any sockets that are loosely fitted or not working</li><li>✓ Check for and report and broken fans or lights</li></ul>

### ***Example of simple Socket Tester to check an electrical socket***

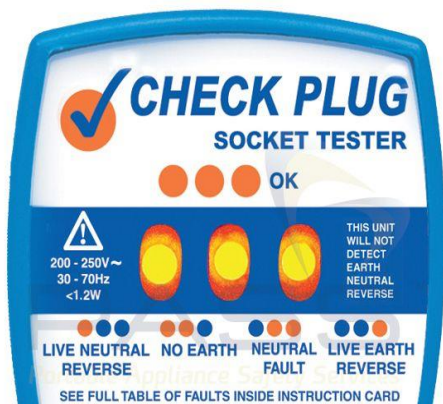

Plug the Socket Tester into a live socket and switch the socket on.

Indicator lamps across the front of the unit provide a clear indication of a correctly wired socket.

Fault indications are quickly identified using the label:

- Line Neutral Reverse
- No Earth
- Neutral Fault
- Live Earth Reverse
- These devices will not detect Earth Neutral Reverse

## Chapter 9. References

- BMET/BMEAT training courses  
Nick Simons Institute, Kathmandu, 2009
- Care and Safe Use of Hospital Equipment  
Skeet and Fear, VSO Books, 1995
- Franks Hospital Workshop  
[www.frankshospitalworkshop.com](http://www.frankshospitalworkshop.com). (Last accessed 15/4/2015)
- Helen Day, [www.medicalartist.org.uk](http://www.medicalartist.org.uk)  
(illustrations on pages 9, 12, 15, 18, 21, 24, 27, 30, 33, 36, 39, 42, 45, 48, 51, 54, 57, 60, 66, 69, 72)
- How to Organise a System of Healthcare Technology Management  
Guide 1, 'How to Manage' series, Ziken International. TALC, St Albans, 2005.  
[www.ziken.co.uk/our\\_expertise/how\\_to\\_manage\\_series.html](http://www.ziken.co.uk/our_expertise/how_to_manage_series.html)  
(source of illustration on page 7)
- How to Operate Healthcare Technology Effectively and Safely  
Guide 4, 'How to Manage' series, Ziken International. TALC, St Albans, 2005.
- Maintenance and Repair of Laboratory, Diagnostic Imaging and Hospital Equipment  
WHO, Geneva, 1994.  
(source of illustrations on pages 36, 63)
- Maintenance Manual for Laboratory Equipment (2<sup>nd</sup> Edition)  
WHO, Geneva, 2008.
- Maintenance of Cold Chain Equipment  
Ministry of Health and Family Welfare, New Delhi, 2009
- Manual on the management, maintenance and use of blood cold chain equipment  
WHO, Geneva 2005
- Medical Instrumentation in the Developing World  
R Malkin, Engineering World Health, Duke University, 2006
- Procedure For Condemnation And Disposal Of Medical And Allied Equipment  
Ministry of Health and Family Welfare, New Delhi, 2010
- Sterilisation of Medical Supplies by Steam  
Huys J. HEART Consultancy, Renkum, 2004.
- WHO Manual of Diagnostic Imaging  
WHO, Geneva, 2003.
- X-ray Equipment Maintenance and Repairs Workbook for Radiographers and Radiological Technologists  
WHO, Geneva 2004.

All illustrations are available for reproduction without cost, providing source is acknowledged.